

# RTKLIB ver. 2.2.2 Manual



2009/09/07

## Contents

1	Overview .....	1
2	System Requirement .....	3
3	Instructions .....	4
3.1	Installation.....	4
3.2	Real-time Positioning with RTKNAVI.....	5
3.3	Configure Input, Output and Log Streams for RTKNAVI.....	15
3.4	Post-Processing Analysis with RTKPOST .....	19
3.5	Configure Positioning Options for RTKNAVI and RTKPOST .....	23
3.6	Convert Receiver Raw Data to RINEX with RTKCONV.....	32
3.7	View and Plot Solutions and Observation Data with RTKPLOT.....	35
3.8	NTRIP Source Table Browser.....	41
3.9	Use Console APs of RTKLIB .....	43
4	Develop and Link user AP with RTKLIB .....	44
	Appendix A Console AP Commands .....	45
A.1	RNX2RTKP.....	45
A.2	POS2KML.....	47
A.3	CONVBIN .....	48
A.4	SBSPOS .....	50
A.5	SBSDUMP.....	51
	Appendix B File Formats.....	52
B.1	Positioning Solution File.....	52
B.2	SBAS Log File.....	55
	Appendix C Library APIs (Application Program Interfaces).....	56

# 1 Overview

RTKLIB is an open source program package for RTK-GPS. RTKLIB consists of a simple and portable program library and several application programs (APs) utilizing the library. The program library of RTKLIB provides:

- (1) Matrix and vector functions
- (2) Time and string functions
- (3) Coordinates transformation and geoid model
- (4) Navigation processing
- (5) Positioning models (troposphere, ionosphere, antenna PCV)
- (6) SBAS DGPS correction
- (7) Single point positioning
- (8) Carrier-based and code-based relative positioning
- (9) OTF integer ambiguity resolution
- (10) Receiver raw binary data input
- (11) Positioning solution/NMEA input/output
- (12) RINEX observation data/navigation message input/output
- (13) Precise ephemeris input
- (14) Stream data communication library
- (15) NTRIP (Networked Transport of RTCM via Internet Protocol) library
- (16) RTK-GPS positioning server
- (17) RTCM 2.3 and 3.0/3.1 message handling

The GUI and console (command line) APs of RTKLIB includes:

- (1) Real-time positioning (RTKNAVI)
- (2) Post-mission baseline analysis (RTKPOST, RNX2RTKP)
- (3) Communication utility (STRSVR)
- (4) Plot graph of positioning solution and observation data (RTKPLOT)
- (5) RINEX converter of receiver raw data log (RTKCONV, CONVBIN)
- (6) Other positioning utilities

All of the executable binary APs for Windows are included in the package as well as whole source programs of the library and the APs.

The receiver have to output raw measurement data of pseudorange/carrier-phase and satellite ephemerides. NRTK (Network RTK) service supporting RTCM 2 or 3 can also be used for the base-station. Please refer Release Notes for supported receivers and data messages. The post-processing baseline analysis can process RINEX 2.10 or 2.11 observation data and navigation messages supported by many receivers. Future version will support other GNSSs such as GLONASS, Galileo and QZSS.

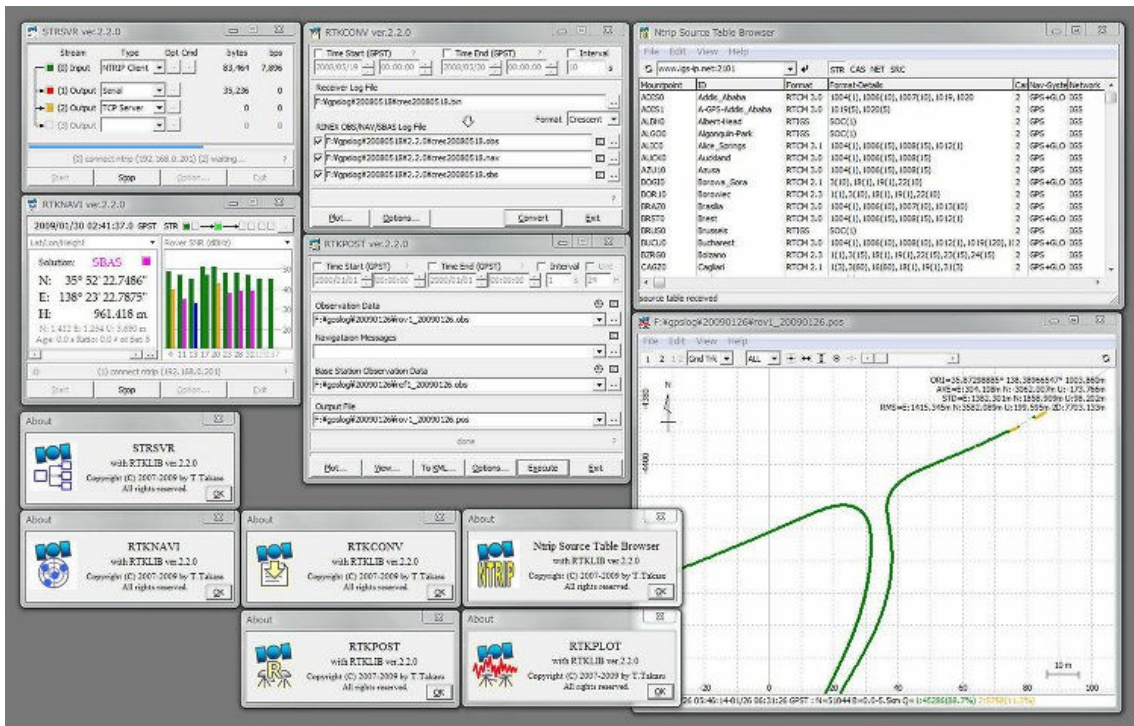

## 2 System Requirement

The library and its APIs of RTKLIB use standard ANSI C (89) functions. The library internally use standard socket and pthread APIs for Linux/UNIX or winsock and WIN32 thread for Windows. By setting compiler option -DLAPACK or -DMKL, the library uses LAPACK/BLAS or Intel MKL for fast matrix computation.

The console APs are also written in standard C and APIs. They can be built on many environments like gcc on Linux or MAC OS X. The GUI APs are written in C++ and utilize Borland VCL for the GUI library.

All of the binary (console and GUI) APs in the package were built by free edition Borland Turbo C++ (<http://www.turboexplorer.com>) on Windows. The binary APs were tested on Windows XP pro SP3 32bit and Windows Vista Home 64bit.

## 3 Instructions

### 3.1 Installation

- (1) Extract the program package `rtklib_<ver>.zip` or `rtklib_<ver>_bin.zip` to appropriate directory (<ver> indicates the version number). The RTKLIB directory structure is as follows.

<code>rtklib_&lt;ver&gt;</code>	
<code>\src</code>	: Source programs of RTKLIB libraries *
<code>\rcv</code>	: Source programs depending on GPS/GNSS receivers *
<code>\bin</code>	: Executable binary APs and DLLs for Windows
<code>\data</code>	: Sample data for APs
<code>\app</code>	: Build environment for APs *
<code>\rtknavi</code>	: RTKNAVI (GUI) *
<code>\strsvr</code>	: STRSVR (GUI) *
<code>\rtkpost</code>	: RTKPOST (GUI) *
<code>\rtkpost_mkl</code>	: RTKPOST_MKL (GUI) *
<code>\rtkplot</code>	: RTKPLOT (GUI) *
<code>\rtkconv</code>	: RTKCONV (GUI) *
<code>\srctblbrows</code>	: NTRIP source table browser (GUI) *
<code>\rnx2rtkp</code>	: RNX2RTKP (console) *
<code>\pos2kml</code>	: POS2KML (console) *
<code>\convbin</code>	: CONVBIN (console) *
<code>\sbsdump</code>	: SBSDDUMP (console) *
<code>\sbspos</code>	: SBSPOS (console) *
<code>\str2str</code>	: STR2STR (console) *
<code>\appcmn</code>	: Common routines for GUI APs *
<code>\icon</code>	: Icon data for GUI APs *
<code>\mkl</code>	: Intel MKL libraries for Borland environment *
<code>\test</code>	: Test program and data *
<code>\util</code>	: Utilities *
<code>\doc</code>	: Document files

\* Not included in the package `rtklib_<ver>_bin.zip`

- (2) Create the shot-cuts of the GUI AP executable binaries in `rtklib_<ver>\bin`. To execute console APs, add `<install_dir>\rtklib_<ver>\bin` to the command path.

### 3.2 Real-time Positioning with RTKNAVI

Real-time positioning AP RTKNAVI inputs raw observation data of GPS/GNSS receivers and execute navigation processing in real-time. By setting the positioning mode to Kinematic and configuring the rover and the base station receiver data inputs, RTK-GPS/GNSS positioning is enabled with OTF (On-the-fly) integer ambiguity resolution.

- (1) Execute the binary AP file `rtklib_<ver>\bin\rtknavi.exe`. (Double-click the icon or full in the path in the command console) You can see the main window of RTKNAVI.

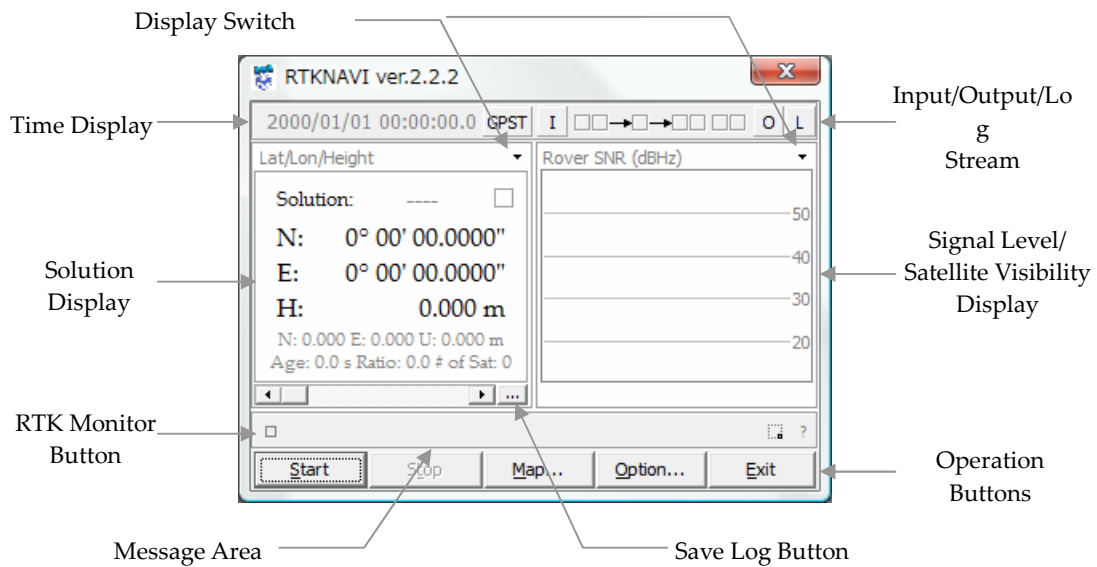

- (2) The following figure shows the data flow of RTKNAVI. You have to set Input Streams, Output Streams (optional) and Log Streams (optional) for real-time positioning.

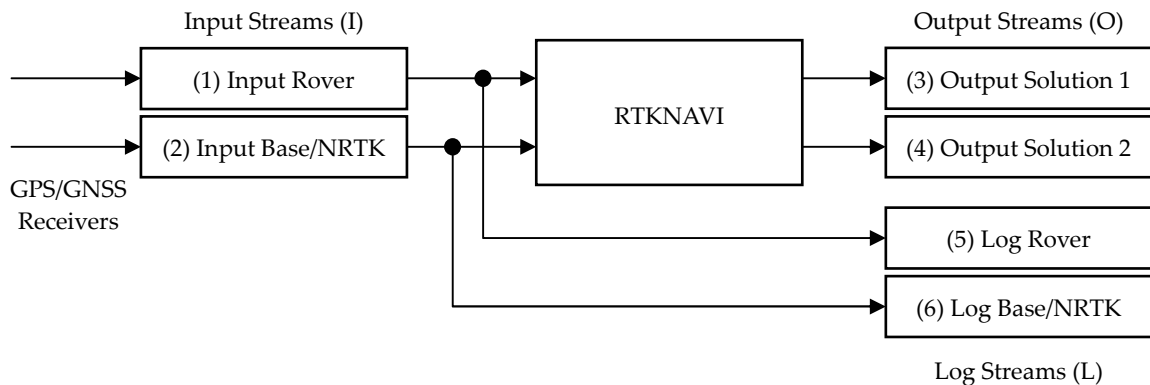

- (3) For real-time positioning with RTKNAVI, you have to input the raw observation data and satellite ephemerides from the GPS/GNSS receivers. To set the input stream, push the button I upper center in the main window. You can see "Input Streams" dialog.

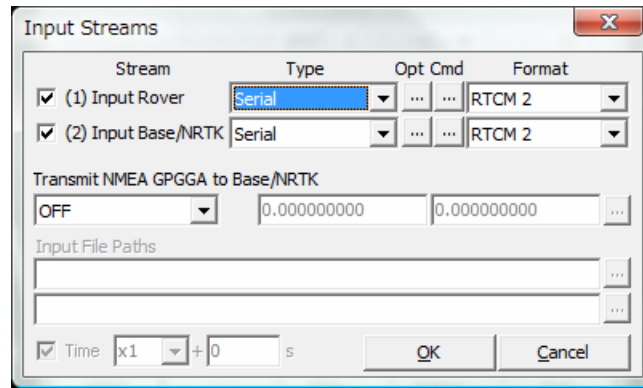

- (4) Check and set the stream type of the rover and the base-station/NRTK (network RTK) in the dialog. If you set the positioning mode option "Single", the input stream for the base-station/NRTK is not required. The stream types can be selected from the following options.

- (a) Serial : Input data from a serial port (RS232C or USB)
- (b) TCP Client : Connect to a TCP server and input data via the TCP connection
- (c) TCP Server : Accept a TCP client connection and input data via the TCP connection
- (d) NTRIP Client : Connect to a NTRIP server (caster) and input data via the NTRIP.  
NRTK (network RTK) server supporting NTRIP and RTCM 2/3 can also be used for the base-station via Internet.
- (e) File : Input data from a log file.

You have to select the stream data format from the following options with the pull down menu under "Format". Refer Release Notes for the detailed supported messages.

- (a) RTCM2 : RTCM 2.3
- (b) RTCM3 : RTCM 3.0 or 3.1
- (c) NovAtel OEM4/V : NovAtel OEM4/V binary format
- (d) NovAtel OEM3 : NovAtel OEM3 (Millennium) binary format
- (e) u-blox : u-blox LEA-4T/5T binary format
- (f) Superstar II : NovAtel Superstar II binary format
- (g) Crescent : Hemisphere Crescent binary format

- (5) If you select Serial as the stream type, push  button under "Opt" label to set the options of port selection, bit-rate, byte size, parity, number of stop bits and flow control with "Serial Options" dialog.

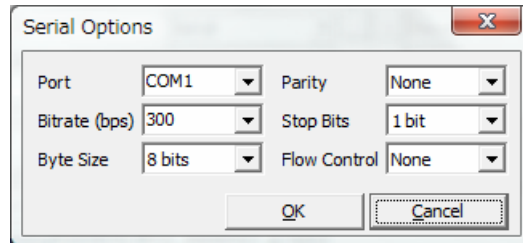

- (6) In case of selecting Serial as the stream type, you can configure the startup and shutdown commands to be sent to the GPS/GNSS receiver. Push  button under "Cmd" label. Fill in the commands in the text fields in "Serial Commands" dialog. If you do not check "Commands at startup" or "Commands at shutdown", the startup or shutdown command is not sent to the receiver. You can also load the commands from a command file by pushing  button or save the commands to a command file with  button. The command file is the just text file including the startup commands and the shutdown commands separated by a line starting with "@". The sample command files for some typical receivers are found in the directory `rtklib_<ver>/data`.

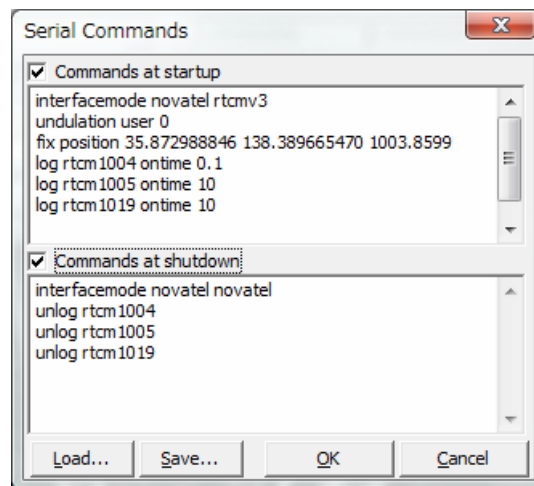

- (7) If you select TCP Client or TCP Server as the stream type, you can set the options of TCP server address (for TCP Client only) and port number with "TCP Client Options" or "TCP Server Options" dialog.



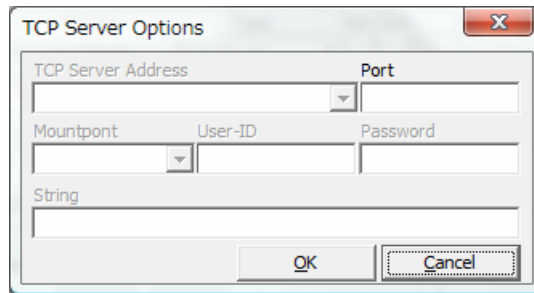
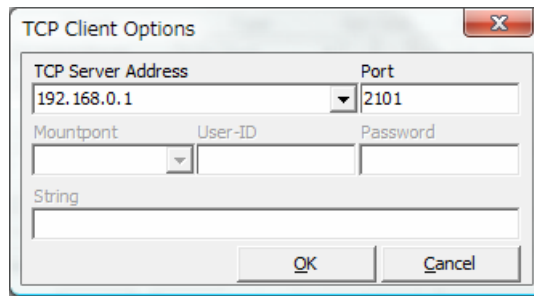

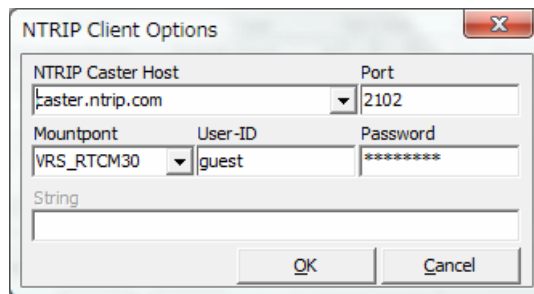

- (8) If you select NTRIP Client as the stream type, you can set the NTRIP client options of NTRIP caster host address, port number, mountpoint of NTRIP caster, user-ID and password with "NTRIP Client Options" dialog.

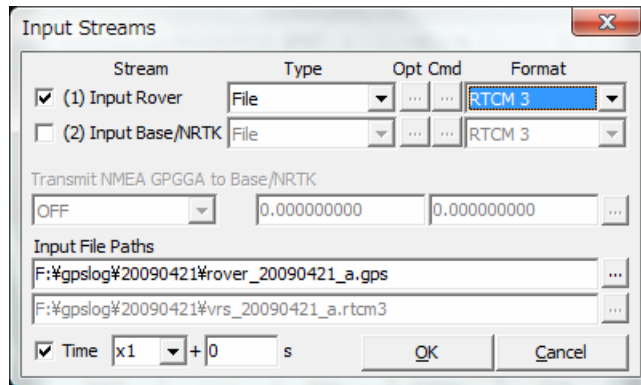

- (9) If you select File as the stream type, input the file path to the text field Input File Paths. Fill in the path directly or select a file with the file selection dialog by pushing [...] button. The input file should be a receiver raw data log. You can set the replay speed and the start time offset of the log file in Time field (To use the feature, you have to record the log with the time-tag file.)



(10) In case of using NRTK (network RTK) service, which requires NMEA GPGGA messages to select reference station or to get virtual reference station position, select the message content with the pull down menu at Transmit NMEA GPGGA to Base/NRTK. If you select Latitude/Longitude to send fixed position, fill in the latitude and longitude for NMEA GPGGA message in degree (minus means south or west).

(11) To output of the positioning solution of RTKNAVI, set the output streams. To set the output streams, push the button  upper right in the main window. You can see "Output Streams" dialog. Check and set the stream type of solution in the dialog. You can configure two independent output streams. You can select the stream type out of Serial, TCP Client, TCP Server, NTRIP Server and File. The options are similar to the input streams. You also have to select the following output format options. The time and latitude/longitude formats in output messages can be configured by the positioning options.

- (a) Lat/Lon/Height : Latitude, longitude and height
- (b) X/Y/Z-ECEF : X/Y/Z components in ECEF frame
- (c) E/N/U-Baseline : E/N/U components of the baseline
- (d) NMEA-183 : NMEA GPRMC, GPGGA, GPGSV (1Hz only)

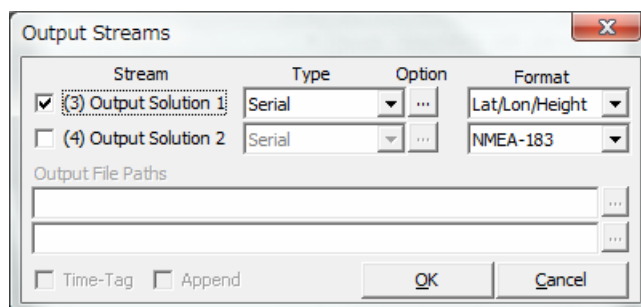

(12) To output an input stream as a path-through log, set the log streams. To configure the log streams,

push the button **L** upper right in the main window. You can see "Log Streams" dialog. The settings are similar to the output streams. If you want to replay the log file as an input stream later, you have to check "Time-Tag" option and output the time tag file simultaneously. The output path of the time tag file is output file path + **.tag**.

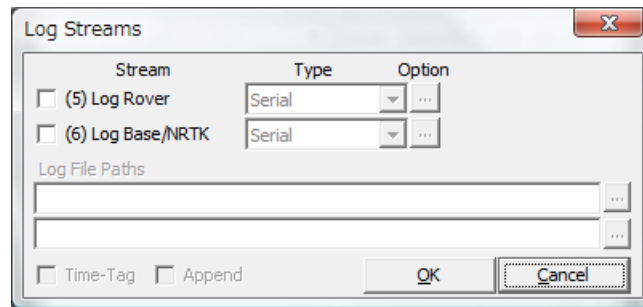

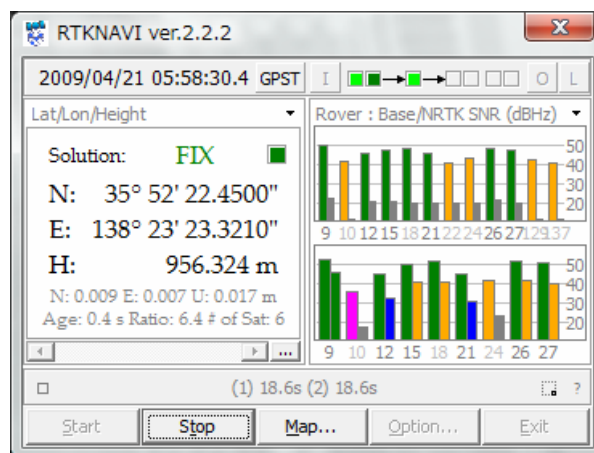

(13) To configure the positioning options, push **Options...** button and set the options in "Options" dialog. For details of the positioning options, refer 3.5 Configure Positioning Options for RTKNAVI and RTKPOST.

(14) Push **Start** button. The status of each streams are shown on the upper right indicators. From the left, they show the stream/processing status of Input Rover, Input Base/NRTK, the positioning process, Output Solution 1, Output Solution 2, Log Rover and Log Base/NRTK. **Gray** represents not used, **Orange** means waiting for the connection, **Deep-green** means connected or running, **Light-green** means data active (input, output or processing) and **Red** means a communication error occurs. Some status messages also are shown in the lower center message area in the main window. To stop the positioning process in RTKNAVI push **Stop** button.



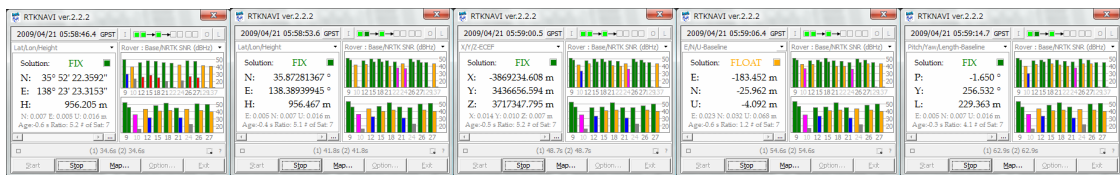





- (15) After the input observation data and ephemerides are completed and valid, RTKNAVI computes the positioning solution and display it in the solution display left in the main window with the solution status (FIX, FLOAT, DGPS, SBAS or SINGLE), E/N/U or X/Y/Z components of the standard deviation, Age (age of differential), Ratio (ratio factor of ambiguity validation) and # of Sat (number of valid satellites). To switch the format in the solution display, push  button upper right corner. You can switch the solution to Lat/Lon/Height (degree/minute/second), Lat/Lon/Height (degree), X/Y/Z-ECEF (m), E/N/U-Baseline (m), Pitch/Yaw/Length-Baseline (deg, m), alternatively.

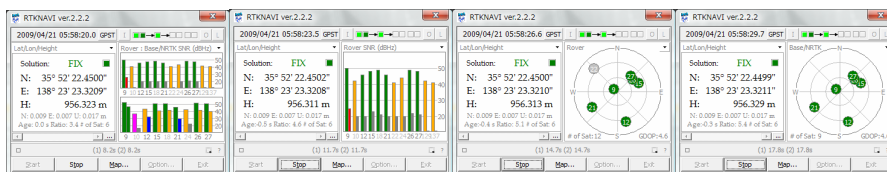





- (16) To switch the format in the time display, push  button upper center in the main window. You can switch the time system to GPST, UTC, JST and GPST (GPS week/TOW), alternatively.

- (17) In the status display right in the main window, observation SNR status or visible satellites in skyplot are shown. By pushing  button upper right corner of the status display, you can switch the contents to Rover : Base/NRTK SNR, Rover SNR, Rover Skyplot and Base/NRTK Skyplot, alternatively.

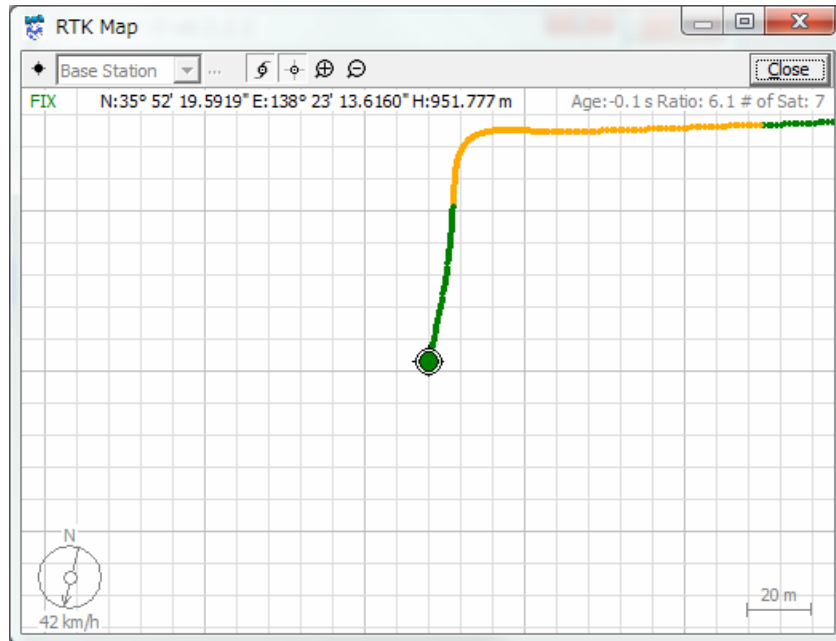



- (18) By pushing  button, you can display "RTK Map" window indicating the current position of the rover receiver on the map. To expand or shrink the scale of the map, push  or  button upper in the window. To fix the current receiver position at the map center, use  button. The button  is also used to switch on/off of the receiver trajectory. To close the window, push  button.

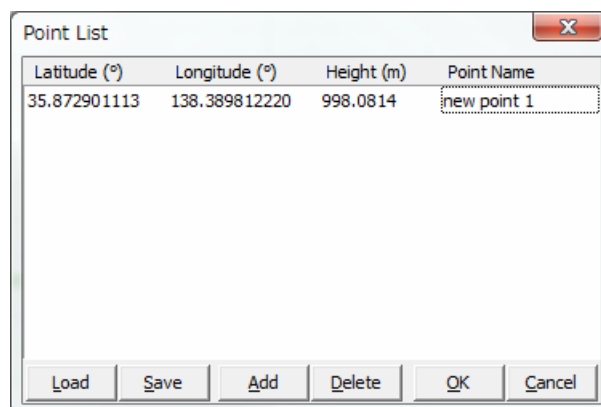

(19) On the "RTK Map" window, by pushing  button and  at upper left corner, you can see the "Point List" dialog. With the dialog, you can load, save, add and delete the way-points as the list form. By pushing  button and editing the point name, the current receiver position can be added to the way-point list. The positions of the way-points as well as the base-station are also shown on the map when  button down.



(20) The positioning solutions are recorded in the internal buffer simultaneously. You can save the internal solution buffer to the file by pushing  below the solution display. The size of the solution buffer and the saved solution log can be configured with "Options" dialog.

(21) By pushing the  button lower left in the main window, you can see "RTK Monitor" window. With the

window, you can monitor the internal status of RTKNAVI. You can select the following contents with the upper left pull down menu. Multiple "RTK Monitor" windows are allowed. To close the window, push Close button.

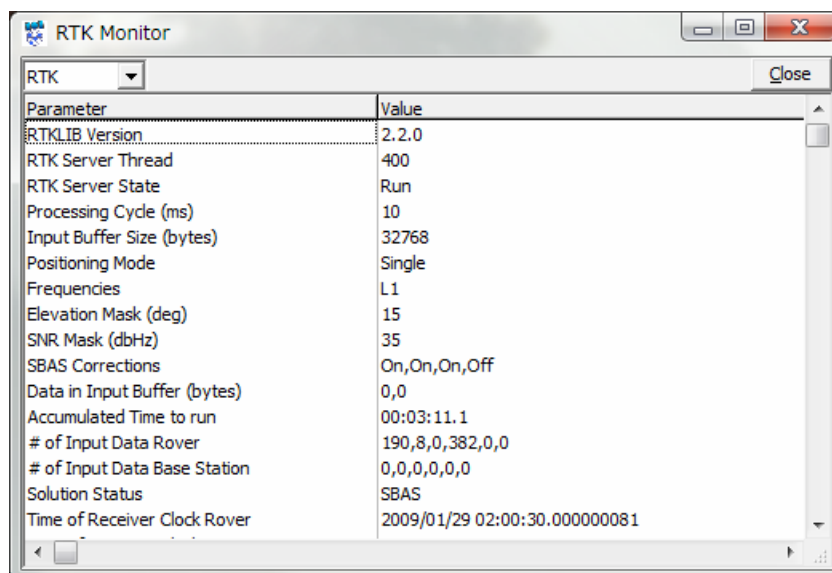

- (a) RTK : General status of the internal positioning process
- (b) Satellites : Status of each satellites
- (c) States : State vector values of the estimation filter
- (d) Covariance : Covariance matrix of the estimation filter
- (e) Obs Data : Input observation data. RCV=1 means rover and 2 means base-station
- (f) Nav Data : Input navigation messages
- (g) Streams : Status of input, output and log streams
- (h) SBAS Msgs : HEX dump of input SBAS messages
- (i) SBAS Long : SBAS long term satellite corrections
- (j) SBAS Iono : SBAS ionospheric delay corrections
- (k) SBAS Fast : SBAS fast corrections
- (l) GEO Nav : SBAS GEO navigation messages
- (m) RTCM : Status of RTCM 2 or 3 messages
- (n) RTCM DGPS : RTCM DGPS corrections
- (o) Input Rover : Dump of Input Rover stream
- (p) Input Base/NRTK : Dump of Input Base/NRTK stream
- (q) Solution 1/2 : Dump of Output Solution 1/2 stream
- (r) Error/Warning : Error or warning messages

(22) By pushing  button lower right in the main window, you can minimize the main window as an icon in the task-tray of Windows desktop. To restore the main window, double-click the task-tray-icon or click right-button on the task-tray-icon and select menu "Main Window...".

### 3.3 Configure Input, Output and Log Streams for RTKNAVI

For relative positioning like RTK-GPS, the rover receiver and the base station receiver are usually placed on the separated sites. In other cases, user might use the positioning result at the remote site far from these receivers. To interconnect these sites, user has to establish data communication links. To facilitate easy setup of these communication links, RTKLIB provides the communication utility STRSVR, with which user can configure input and output data stream via these communication links. STRSVR also has the function of relay or split the data stream for real-time positioning with RTKNAVI.

For example, to receive observation data of a remote base station at a rover receiver site and to get RTK-GPS solution, user can place a remote PC installing STRSVR connecting to the base station receiver and can configure STRSVR to send data to the rover site. The following examples show the typical applications of RTKNAVI and SVRSVR.

- (1) Single-point positioning and output solutions to a file

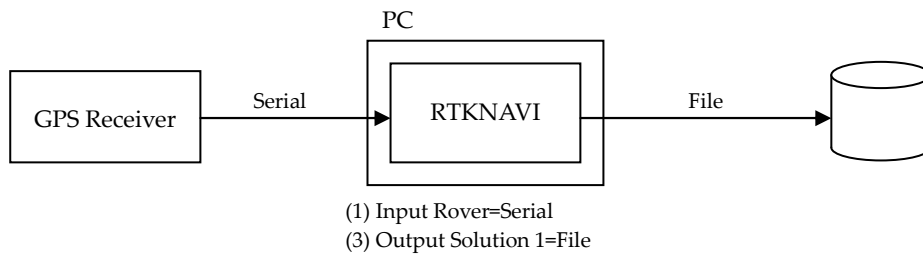

- (2) Single point positioning, output solutions to a serial device, log data to a file

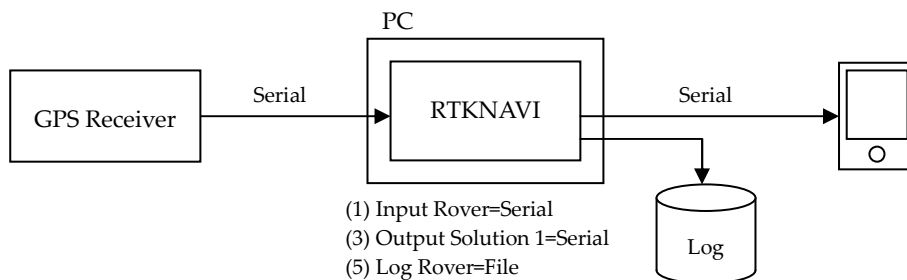

- (3) RTK-GPS, input the rover and base-station data from two serial devices

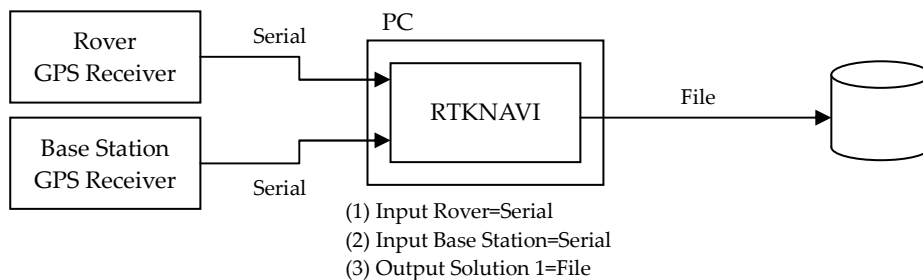



- (4) RTK-GPS, input rover data from a serial port and input base-station data from a remote receiver via WiFi network.

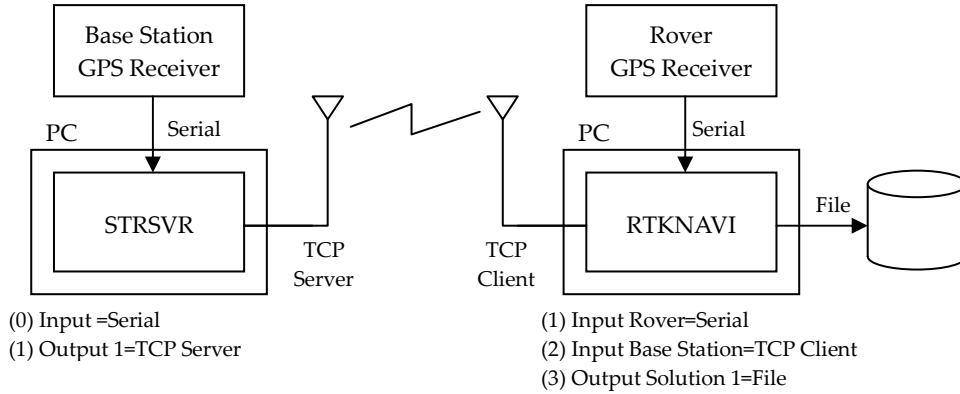

- (5) RTK-GPS, input rover data from a serial port and input base station data via mobile phone Internet connection

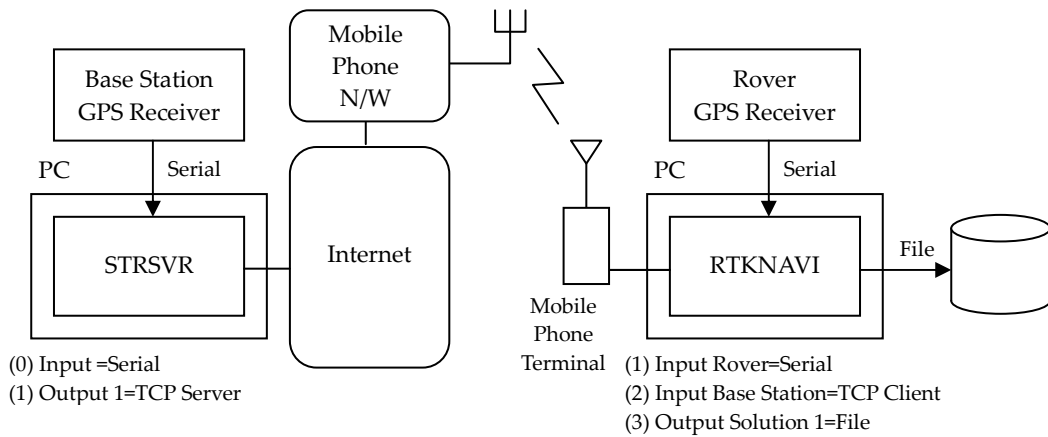

- (6) RTK-GPS, input data from a serial port and input base station data via NTRIP caster on Internet

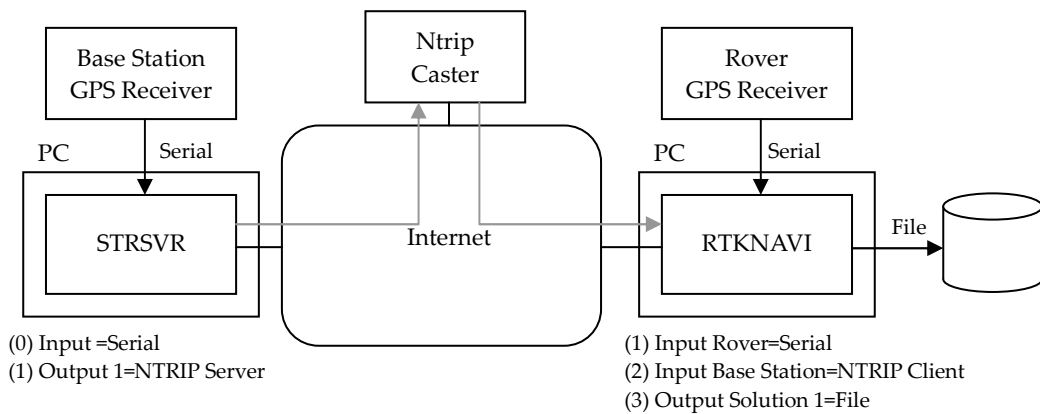

(7) RTK-GPS with NRTK (Network RTK) service via Internet

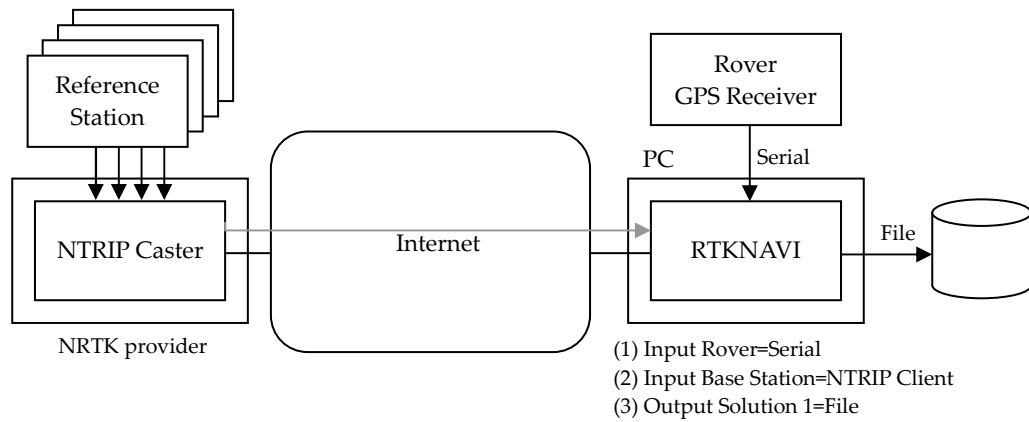

The following instructions are for the operation of STRSVR.

- (1) Execute the binary AP file `rtklib_<ver>\bin\strsvr.exe`. You can see the main window of STRSVR.

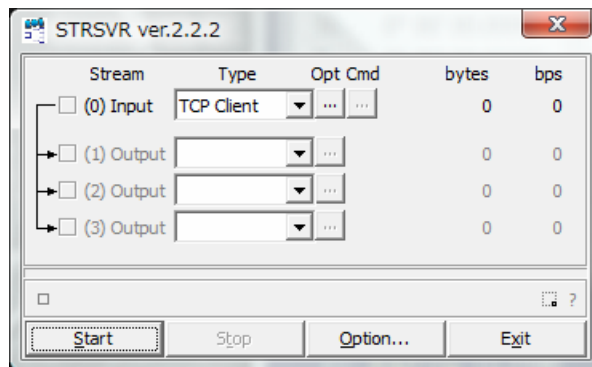

- (2) To configure the input stream, select the stream type with pull down menu at "(0) Input". Selectable stream types are Serial, TCP Client, TCP Server, NTRIP Client and File. The stream options or the startup/shutdown command can be set as well as Input Streams for RTKNAVI.
- (3) To configure the output streams, select the stream type with pull down menu at (1) Output, (2) Output or (3) Output. The setting for the output streams are same as Output Streams or Log Streams for RTKNAVI.
- (4) Push **Start** button in the main window. The communication status is shown in the message area lower center of the main window. Status indicators left side of the main window also shows the

communication status. The indicator colors means: **Orange**: waiting connection, **Dark-Green**: connected, **Light-Green**: data active, **Red**: error. Total data amount (bytes) and data rate (bps) of the input and output streams are also shown in right side. To stop the communication, push **Stop** button.

- (5) By pushing **Options...** button, you can set the communication options with "Options" dialog. To send NMEA GPGGA message to the server connected the input stream, check "NMEA Request Cycle" and set the request cycle (ms) and latitude/longitude in the messages.

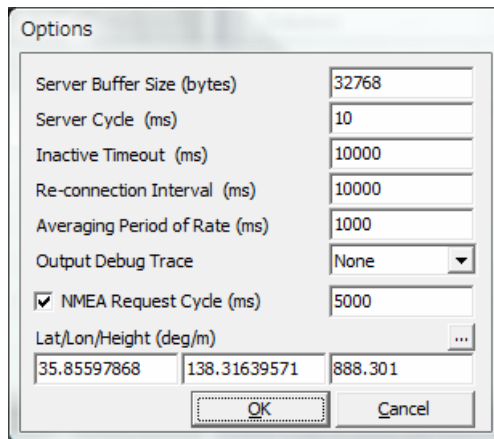

### 3.4 Post-Processing Analysis with RTKPOST

RTKLIB contains a post processing analysis AP RTKPOST. RTKPOST inputs the standard RINEX 2.10 or 2.11 observation data and navigation message files and can compute the positioning solutions by carrier-based relative positioning.

- (1) Execute the binary AP file `rtklib_<ver>\bin\rtkpost.exe`. You can see the main window of RTKPOST. You can execute the binary AP file `rtklib_<ver>\bin\rtkpost_mkl.exe` instead. RTKPOST\_MKL is a faster version of RTKPOST, which link Intel MKL library for fast matrix computation.

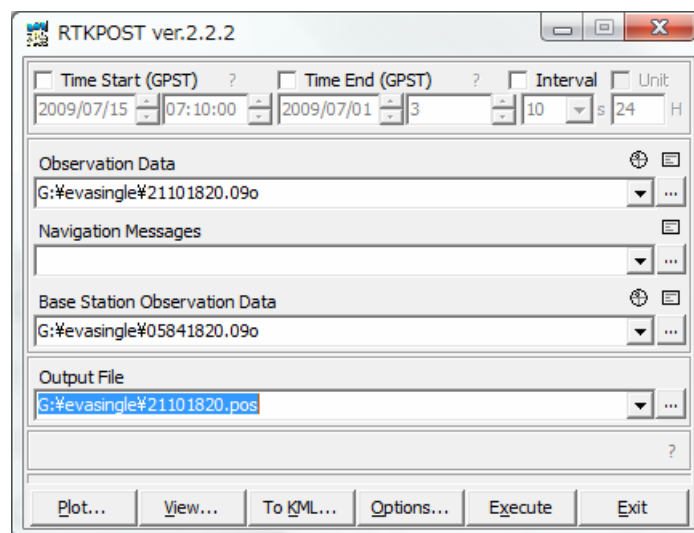

- (2) Input the RINEX observation data file path of the rover receiver in the text field Observation Data. Fill in the file path or select a file using the file selection dialog shown by pushing  button. You also have to input the path of RINEX navigation message file in Navigation Messages field. If you leave it blank, the observation data file path with the extension replaced by `.nav` (`.obs`) or `.yyn` (`.yyo`) is used for the navigation message file. You can use the compressed file by GZIP (`.gz`), COMPRESS (`.z`) or Hatanaka-Compression (`.yyd`) for the RINEX observation data or navigation messages. If a wild-card (`*`) is included in the file path, the wild-card expanded multiple files are used.
- (3) If you process the RINEX data in the positioning mode of DGPS, Kinematic, Static or Moving-Base, input the RINEX observation data file path of the base-station receiver as well as the rover observation data.
- (4) Input the output file path in the text field Output File.

- (5) Push **Options...** button to set the processing options. For detailed options, refer 3.5 Configure Positioning Options for RTKNAVI and RTKPOST. You can set the start time or end time by checking and setting Time Start (GPST) or Time End (GPST) field in the main window. You also set the time interval by checking and setting Interval field. With the **?** button, the input time in GPS time can be converted to UTC, GPS Week/TOW, Day of Year, Day of Week, Time of Day and Leap Seconds.

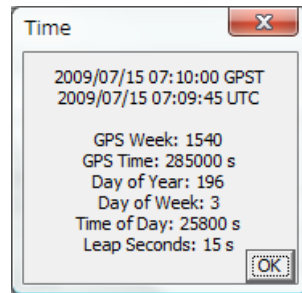

- (6) If you check both of Time Start and Time End, you can check Unit for multiple session analysis. If Unit checked and set the Unit, the analysis session is separated to multiple sessions for the Unit (hr). To avoid overwriting the output to the same file, the output file path has to contain the keyword replaced according to the session time. For details of the keyword replacement in the input or output file paths, refer 3.5 Configure Positioning Options for RTKNAVI and RTKPOST.
- (7) Push **Execute** button to start the analysis. The processing status is shown in the status message field lower center in the main window. When you see "done" message here, the analysis is completed. If you want to stop the processing on the way, push **Abort** button.
- (8) After completing the analysis, by pushing **View...** button, you can display the content of the output file by Text Viewer. You can reload the output file by pushing  button in Text Viewer window. To close the window, push **Close** button.

```

F:\gpslog\20090126\rov1_20090126.pos
Read... Option... Close
% program : RTKLIB ver.2.2.0
% inp file : F:\gpslog\20090126\rov1_20090126.obs
% inp file : F:\gpslog\20090126\ref1_20090126.obs
% inp file : F:\gpslog\20090126\rov1_20090126.nav
% obs start : 2009/01/26 05:46:37.0 GPST (week1516 107197.0s)
% obs end : 2009/01/26 06:31:27.0 GPST (week1516 109887.0s)
% ref pos : 35.872988846 138.389665470 1003.8599
%
% (lat/lon/height=WGS84/ellipsoidal,Q=1:fix,2:float,4:dgps,5:single,ns=# of satellites)
% GPST latitude(deg) longitude(deg) height(m) Q ns sdn(m) sde
2009/01/26 05:46:37.000 35.872899123 138.389811041 997.9515 1 7 0.0077 0.01
2009/01/26 05:46:38.000 35.872899095 138.389811053 997.9644 1 7 0.0076 0.01
2009/01/26 05:46:39.000 35.872899081 138.389811008 997.9637 1 7 0.0053 0.01
2009/01/26 05:46:40.000 35.872899084 138.389811030 997.9566 1 7 0.0053 0.01
2009/01/26 05:46:41.000 35.872899099 138.389811040 997.9551 1 7 0.0053 0.01
2009/01/26 05:46:42.000 35.872899080 138.389810994 997.9588 1 7 0.0076 0.01
2009/01/26 05:46:43.000 35.872899091 138.389811063 997.9608 1 7 0.0076 0.01
2009/01/26 05:46:44.000 35.872899108 138.389811087 997.9558 1 7 0.0076 0.01
2009/01/26 05:46:45.000 35.872899065 138.389811017 997.9621 1 7 0.0054 0.01
2009/01/26 05:46:46.000 35.872899088 138.389811024 997.9565 1 7 0.0054 0.01
2009/01/26 05:46:47.000 35.872899094 138.389811012 997.9636 1 7 0.0054 0.01
2009/01/26 05:46:48.000 35.872899080 138.389811010 997.9613 1 7 0.0054 0.01
2009/01/26 05:46:49.000 35.872899101 138.389811023 997.9576 1 7 0.0054 0.01
2009/01/26 05:46:50.000 35.872899125 138.389811038 997.9558 1 7 0.0054 0.01
2009/01/26 05:46:51.000 35.872899120 138.389811057 997.9566 1 7 0.0076 0.01

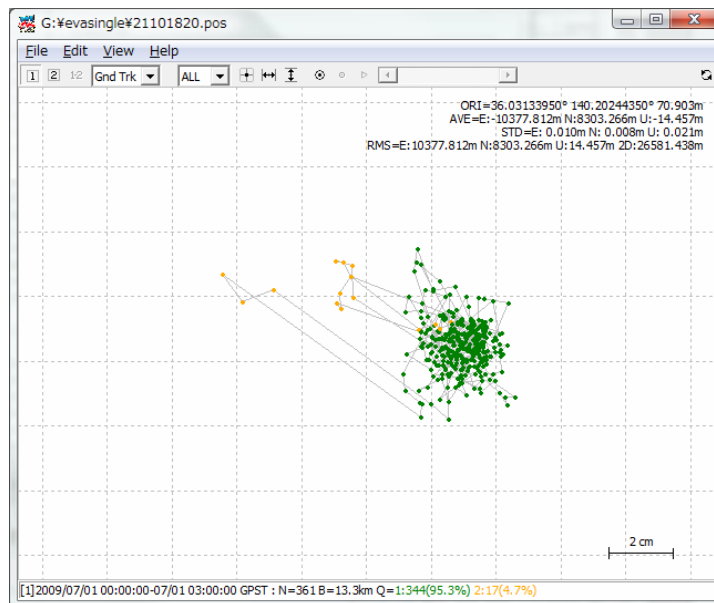

```

(9) By pushing **View...** button, you can also plot the result with RTKPLOT. Refer 3.7 View and Plot Solutions and Observation Data with RTKPLOT for details.

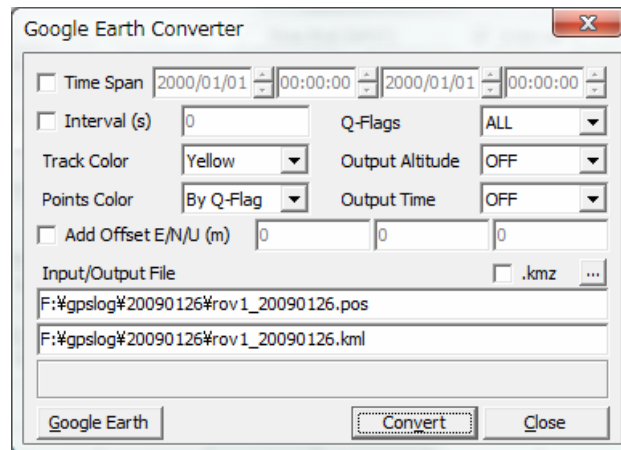

(10) By pushing **To KML...** button, the output file can be converted to Google Earth KML file with "Google Earth Converter" dialog. Set or select the options and push **Convert** button in the dialog.



- (11) With  button in the main window, you can view and plot the input observation data RTKPLOTT. You can also display the contents of the input files with Text Viewer by pushing  button.

### 3.5 Configure Positioning Options for RTKNAVI and RTKPOST

By pushing Options... button in the main windows of RTKNAVI or RTKPOST, you can set the positioning options. Selectable or changeable positioning options are as follows.

(1) Setting 1

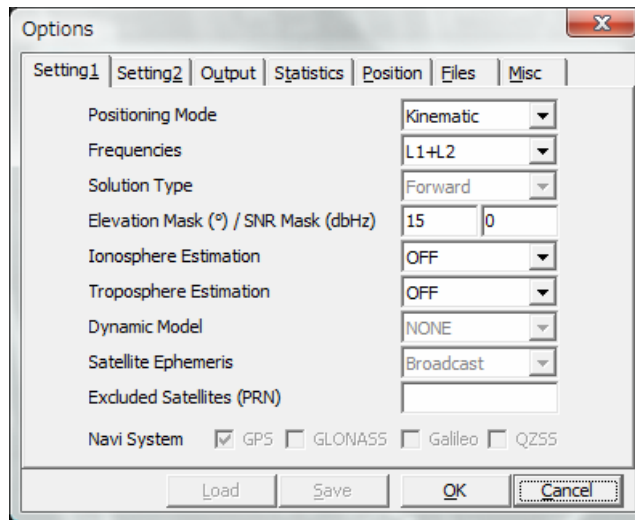

Item	Descriptions	Notes
Positioning Mode	Set positioning mode - Single : Single point positioning or SBAS DGPS - DGPS : Code-based differential GPS - Static : Carrier-based Static positioning - Kinematic: Carrier-based Kinematic positioning - Moving-Base: Moving baseline	
Frequencies	Set used carrier frequencies - L1 : L1 only - L1+L2 : L1 and L2	
Solution Type	Set solution type - Forward: Forward filter solution - Backward: Backward filter solution * - Combined: Smoother combined solution with forward and backward filter solutions *	* RTKPOST only
Elevation Mask	Set elevation mask angle (deg)	
SNR Mask	Set SNR mask (dBHz)	
Ionosphere Estimation	Set whether ionospheric parameters (vertical ionospheric delay for a satellite) are estimated or not. For long baseline analysis, ionosphere estimation is effective to suppress ionosphere delay effects. - OFF : Not estimate ionospheric parameters - ON : Estimate ionospheric parameters	



Item	Descriptions	Notes
Troposphere Estimation	Set whether tropospheric parameters (zenith total delay at rover and base-station positions) are estimated or not. - OFF : Not estimate tropospheric parameters - ON : Estimate tropospheric parameters	
Dynamic Model	Set the dynamics model of the rover receiver. (current version does not support the option)	
Satellite Ephemeris	Set the type of satellite ephemeris. - Broadcast : Use broadcast ephemeris - Precise : Use precise ephemeris * If using precise ephemeris, set the precise ephemeris file path in Files settings	* RTKPOST only
Excluded Satellites (PRN)	Set the excluded satellites for positioning. Fill in the PRN numbers of the satellites separated by spaces.	
Navi System	Set used navigation satellite systems (current version does not support the option)	

## (2) Setting 2

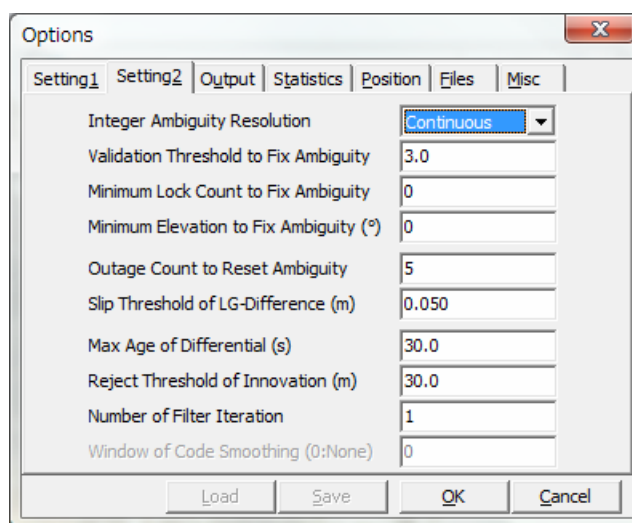

Item	Descriptions	Notes
Integer Ambiguity Resolution	Set the strategy of integer ambiguity resolution - OFF : No ambiguity resolution - Continuous : Continuously static integer ambiguities are estimated and resolved - Instantaneous : Integer ambiguity is estimated and resolved by epoch-by-epoch basis	
Validation Threshold of AR	Set the integer ambiguity validation threshold for ratio-test, which uses the ratio of squared residuals of the best integer vector to the second-best vector.	
Lock Count to Fix Ambiguity	Set the lock count to fix integer ambiguity. If the lock count is less than the value, the ambiguity is excluded from the fixed integer vector.	

Item	Descriptions	Notes
Outage Count to Reset Ambiguity	Set the outage count to reset ambiguity. If the data outage count is over the value, the estimated ambiguity is reset to the initial value.	
Elevation Mask for AR	Set the elevation mask angle (deg) to fix integer ambiguity. If the elevation angle is less than the value, the ambiguity is excluded from the fixed integer vector.	
Slip Threshold of LG-Difference	Set the cycle-slip threshold (m) of geometry-free LC carrier-phase difference between epochs.	
Max Age of Differential	Set the maximum value of age of differential (s) between the rover and the base station.	
Reject Threshold of Innovation	Set the reject threshold of innovation (pre-fit residual) (m). If the innovation is over the value, the observable is excluded for estimation as an outlier.	
Number of Iteration	Set the number of iteration in the measurement update of the estimation filter.	
Window of Code Smoothing	Set the window size (epochs) for code smoothing. (Current version does not support the option)	

## (3) Output

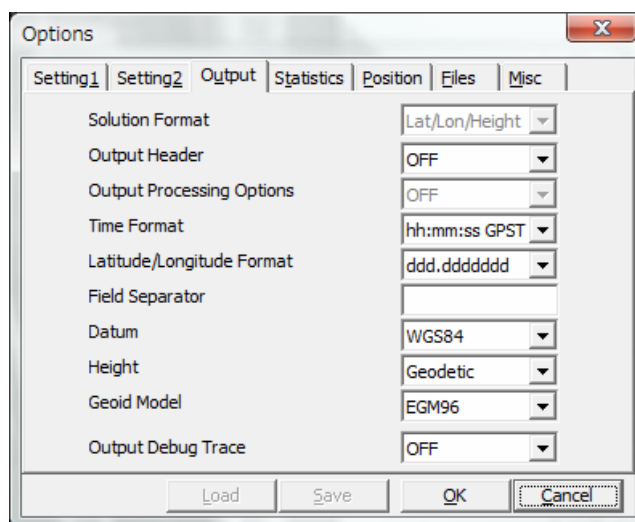

Item	Descriptions	Notes
Solution Format	Set the output solution format. - Lat/Lon/Height : Latitude, longitude and height - X/Y/Z-ECEF : X/Y/Z components of ECEF coordinates - E/N/U-Baseline: E/N/U components of baseline vector - NMEA0183 : NMEA GPRMC, GPGGA, GPGSV	For RTKNAVI, specify options as Output Streams setting.
Output Header	Set whether the header is output or not.	Not applicable to NMEA
Output Processing Options	Set whether the processing options are output or not.	RTKPOST only Not applicable to NMEA

Item	Descriptions	Notes
Time Format	Set the format of time - ssssssss.sss GPST : GPS week and TOW (time of week) - hh:mm:ss GPST : yyyy/mm/dd hh:mm:ss GPST - hh:mm:ss UTC : yyyy/mm/dd hh:mm:ss UTC - hh:mm:ss JST : yyyy/mm/dd hh:mm:ss JST	Not applicable to NMEA
Latitude/Longitude Format	Set the formats of latitude and longitude if the solution format is set to Lat/Lon/Height. - ddd.dddddddd : Degree - ddd mm ss.sss : Degree minute second	Not applicable to NMEA
Field Separator	Set the separator for fields.	Not applicable to NMEA
Datum	Set the datum if the solution format option is set to Lat/Lon/Height. - WGS84 : WGS84 datum - Tokyo : Tokyo datum (current version supports only WGS84)	
Height	Set the type of height. - Ellipsoidal : Ellipsoidal height - Geodetic : Geodetic height	
Geoid Model	Set the geoid model if the Height option is set to Geodetic. - EGM96 : EGM96 model (current version supports only EGM96)	
Output Debug Trace	Set the output level of debug trace file. If setting OFF, any debug trace file is not output. The debug trace file is created in the current directory (RTKNAVI) or in the output file directory (RTKPOST).	

(4) Statistics

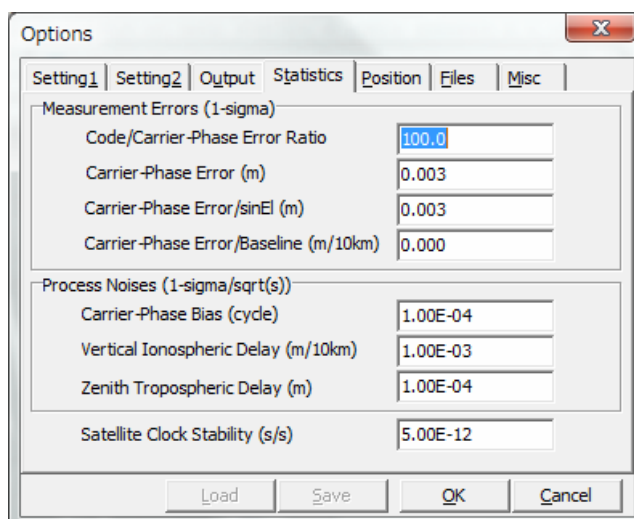

Item	Descriptions	Notes
Measurement Errors (1-sigma)		

Item	Descriptions	Notes
Code/Carrier-Phase Error Rate	Set the ratio of standard deviations of pseudorange errors to carrier-phase errors.	
Carrier-Phase Error	Set the base term of carrier-phase error standard deviation (m).	
Carrier-Phase Error/sinEl	Set the elevation dependent term of carrier-phase error standard deviation (m/sin(el)).	
Carrier-Phase Error/Baseline	Set the baseline-length dependent term of carrier-phase error standard deviation (m/10km).	
Process Noises (1-sigma/sqrt(s))		
Carrier-Phase Bias	Set the process noise standard deviation of carrier-phase bias (ambiguity) (cycle/sqrt(s)).	
Vertical Ionospheric Delay	Set the process noise standard deviation of vertical ionospheric delay per 10 km baseline (m/sqrt(s)).	
Zenith Tropospheric Delay	Set the process noise standard deviation of zenith tropospheric delay (m/sqrt(s)).	
Satellite Clock Stability	Set the satellite clock stability(s/s). The value is used for interpolation of base-station observables.	

## (5) Positions

Item	Descriptions	Notes
Rover		
Lat/Lon/Height (deg/m)	Set the position of the rover antenna if the rover antenna is fixed. (current version does not support the option)	
Antenna Type	Select the type of the rover antenna. To select the antenna type, set the Receiver Antenna PCV File path in Files.	

Item	Descriptions	Notes
Delta-E/N/U	Set the delta position of the rover antenna as the E/N/U offsets of ARP (antenna reference point) position with refer to the marker (m).	
Base Station		
Lat/Lon/Height (deg/m)	Set the position of the base-station antenna. - Lat/Lon/Height (deg/m): Latitude/longitude/height in degree and m - Lat/Lon/Height (dms/m): Latitude/longitude/height in degree/minute/second and m - X/Y/Z-ECEF (m): X/Y/Z components in ECEF frame. - RTCM Station Position: Use the antenna position included in RTCM messages * - Average of Single-Pos: Use the average of single point solutions ** - Get from Position File: Use the position in the position file. The station is searched by using the head 4-character ID of the rover observation data file path. ** - RINEX Header Position: Use the approximate position in RINEX OBS header. **	Height is specified as ellipsoidal height * RTKNAVI only ** RTKPOST only
Antenna Type	Select the type of the base-station antenna. To select the antenna type, set Receiver Antenna PCV File in Files.	
Delta-E/N/U	Set the delta position of the base-station antenna as E/N/U offsets of ARP position with refer to the marker (m).	

If you set Station Position File in "Files" tab, you can select the position of the rover or the base-station antenna from the station list in "Stations" dialog by pushing  button.

No	Latitude(deg)	Longitude(deg)	Height(m)	Id	Name	Dist(km)
1002	40.099699794	140.005495623	46.0467	0923	八竜	11.1
284	39.936054805	140.132376388	56.9366	0186	五城目	13.4
642	39.891134374	139.848934639	65.8312	0551	男鹿2	17.7
133	39.967902919	139.776149785	69.4531	0030	男鹿1	19.4
643	39.825808776	140.044722896	56.6576	0552	天王	19.7
282	40.247295456	140.048679252	84.1521	0184	能代	27.8
283	40.006877779	140.401987861	170.3315	0185	阿仁	34.3
280	40.271156234	140.263661238	75.3796	0182	藤里	37.6
1000	40.339396307	140.027565886	47.7736	0921	八森	37.8
1001	40.183316711	140.408152400	99.5240	0922	鷹巣	40.3
286	39.658309340	140.234212711	74.6913	0188	河辺	42.9
1003	39.921391551	140.535855424	332.5137	0924	阿仁2	46.6
1004	39.527564773	140.053926388	77.8939	0925	岩城	52.7
285	39.749162371	140.597044543	214.0524	0187	西木	58.2
287	39.549292277	140.386624463	83.5518	0189	西仙北	60.0
279	40.325047110	140.577349406	137.3974	0181	大館	61.0
252	40.577642540	139.928116711	47.9983	0154	岩崎	64.4
979	40.576315268	140.296714605	165.2252	0900	西目屋	68.8
881	40.044976285	140.822907284	461.5483	0798	鹿角2	70.4
644	39.702680722	140.732849371	283.1408	0553	田沢湖	70.9
281	40.215439899	140.787334780	167.9461	0183	鹿角	71.3
1005	39.508137491	140.596087860	113.8429	0926	太田	74.8
253	40.523653843	140.578147780	140.2958	0155	大鱈	76.2
632	40.624345250	140.478527382	66.8602	0540	弘前	80.4
977	40.730633547	140.010994485	103.4404	0898	深浦	81.1

(6) Files

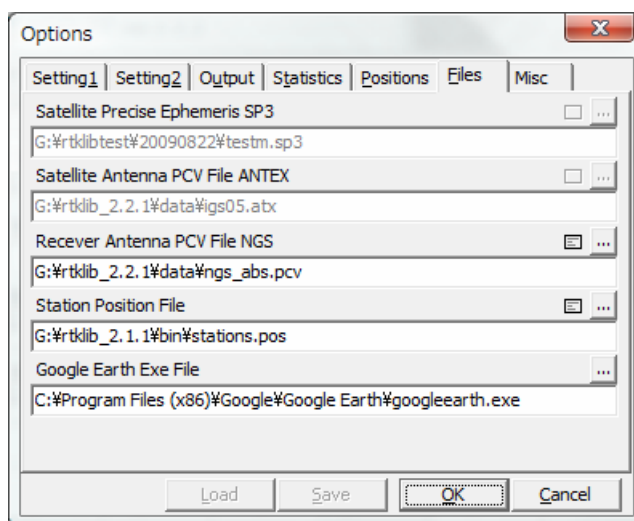

Item	Descriptions	Notes
Satellite Precise Ephemeris SP3	If you select precise ephemeris as Satellite Ephemeris in Setting 1, input the precise ephemeris file path (NGS SP3 format).	RTKPOST only
Satellite Antenna PCV File ANTEX	If you input the precise ephemeris file, input the ANTEX antenna parameters file path for the satellite antenna PCV (phase center variation) correction. Usually use latest <b>igs05.atx</b> file provided by IGS. An example of the ANTEX file is found at <b>rtklib &lt;ver&gt;\data\igs05.atx</b> .	RTKPOST only
Receiver Antenna PCV File NGS	If you apply the receiver antenna phase center offset and PCV correction, input NGS type antenna parameters file path. An example of the antenna parameter file is found at <b>rtklib &lt;ver&gt;\data\ngs_abs.pcv</b> .	
Station Position File	Input the station position file path to retrieve the position from the station list. The station position file is a text file which contains the multiple lines. Each line represents a record for a station. A record contains: - Latitude (deg) - Longitude (deg) - Ellipsoidal height (m) - Station ID - Station name separated by spaces. The line starting "%" is treated as the comment line. An example station position file is found at <b>rtklib &lt;ver&gt;\data\stations.pos</b> .	
Google Earth Exe File	Input the execution file path of Google Earth.	

(6) Misc (RTKNAVI)

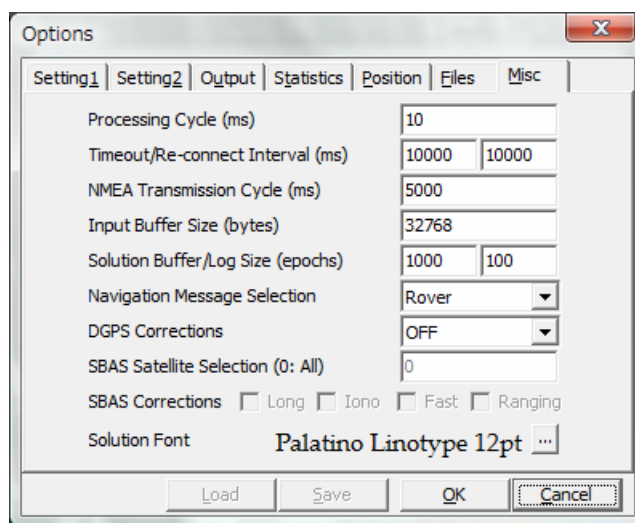

Item	Descriptions	Notes
Processing Cycle	Set the processing cycle time of in ms. Usually set 100 ms or less value.	
Timeout/ Re-Connect Interval	Set the timeout and re-connect interval for TCP client and NTRIP client connections in ms. If the timeout time expired without sever response, RTKNAVI retries to connect to server after waiting for the re-connect interval.	
NMEA Transmission Cycle	Set the NMEA GPGGA transmission cycle to NRTK server in ms.	
Input Buffer Size	Set the internal input message buffer size in bytes. Usually set it to 32768 or more.	
Solution Buffer/Log Size	Set the internal solution buffer size and log size in epochs. To increase the length of the receiver trajectory on "RTK Map", increase the solution buffer size.	
Navigation Message Selection	Select navigation message to be used. - Rover: In rover receiver stream - Base Station: In base station receiver stream - Both: In both streams	
DGPS Corrections	If you want to enable SBAS DGPS corrections, select SBAS. If not, select OFF.	
SBAS Satellite Selection	If SBAS DGPS correction enabled, input SBAS satellite PRN number to be used. If you input 0, all available SBAS satellites are used.	
SBAS Corrections	If SBAS DGPS correction enabled, check enabled corrections of long term, ionospheric, fast corrections and ranging signal.	
Solution Font	Select the font of the solution display in the main window.	

(7) Misc (RTKPOST)

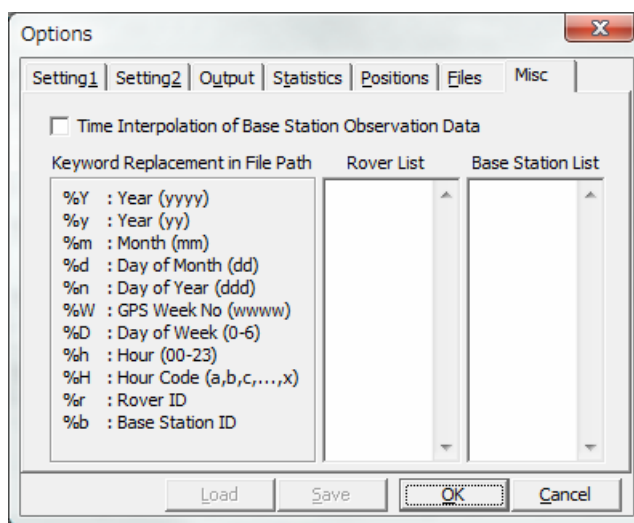

Item	Descriptions	Notes
Time Interpolation of Base Station Observation Data	Check it to enable time interpolation of base station data. If checked, the base station data are linearly interpolated to the rover epoch and DD (double-difference) is made with them. If not checked, nearest epoch of base station data is used for DD.	
Keyword Replacement in File Path	For batch processing with multiple input files or multiple sessions, you can set input file paths or output file path containing the following keywords.  <b>%Y, %y, %m, %d, %n, %W, %D, %h, %H, %r, %b</b>  The keywords are replaced by the proper values or expanded for multiple session analysis. To enable time keywords, set Time Start, Time End and Unit (optional) in the main window. For keywords <b>%r, %b</b> , input Rover List or Base Station List below.	
Rover List	Input the rover ID list to replace keyword <b>%r</b> in input and output file paths.	
Base Station List	Input the base station ID list to replace keyword <b>%b</b> in input and output file paths.	



### 3.6 Convert Receiver Raw Data to RINEX with RTKCONV

RINEX (Receiver Independent Exchange Format) is a standard GPS/GNSS data format supported by many receivers or GPS/GNSS post-processing analysis software. RTKLIB post-processing analysis AP RTKPOST can also handle RINEX data files as inputs. For preparing RINEX files, RTKLIB provides the converter AP RTKCONV, which translates receiver raw data to RINEX OBS (observation data) and RINEX NAV (navigation messages). RTKCONV can also extract SBAS messages from the receiver raw data and output the SBAS log file.

The supported RINEX version is 2.10 or 2.11. RINEX 3.0 will be supported by the future version. Refer the Appendix B.2 SBAS Log File for the SBAS log file format.

- (1) Execute the binary AP file `rtklib_<ver>\bin\rtkconv.exe`. You can see the main window of RTKCONV.

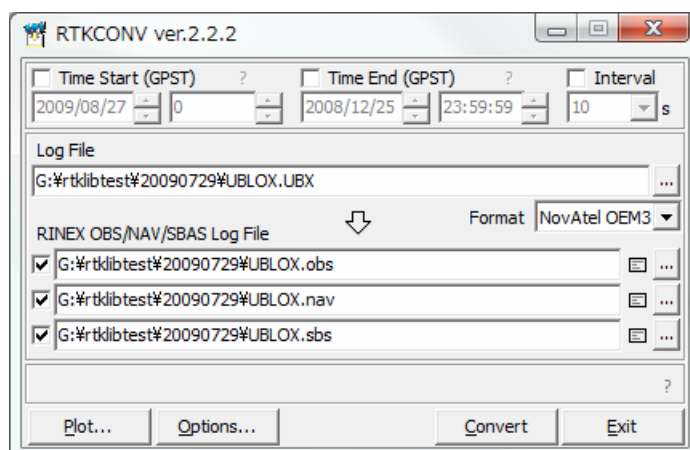

- (2) Input the receiver raw data file path to the text field Log File. Fill in the file path directly or select the file with the file selection dialog by pushing  button. You can also drag and drop the icon of the raw data file to the main window of RTKCONV. Supported receiver raw data formats are as follows. Refer Release Notes for detailed supported messages.

- |                    |   |
|--------------------|---|
| (a) RTCM2          | : RTCM 2.3                                |
| (b) RTCM3          | : RTCM 3.0 or 3.1                         |
| (c) NovAtel OEM4/V | : NovAtel OEM4/V binary format            |
| (d) NovAtel OEM3   | : NovAtel OEM3 (Millennium) binary format |
| (e) u-blox         | : u-blox LEA-4T/5T binary format          |
| (f) Superstar II   | : NovAtel Superstar II binary format      |

- (g) Crescent : Hemisphere Crescent binary format
- (3) Select the format with the pull down menu Format. If you select "Auto", RTKCONV recognizes the file format according to the following file extensions.
- (a) RTCM2 : **.rtcm2**
  - (b) RTCM3 : **.rtcm3**
  - (c) NovAtel OEM4/V : **.gps**
  - (d) u-blox : **.ubx**
  - (e) Superstar II : **.log**
  - (f) Crescent : **.bin**
- (4) Input the output paths of RINEX OBS (observation data), RINEX NAV (navigation messages) and SBAS Log files. Fill in the file path directly or select the file with the file selection dialog by pushing  button. If you do not check the checkbox left, the file is not output.
- (5) You can set the start time or end time optionally by checking and setting Time Start (GPST) or Time End (GPST) field upper in the main window. You can also set the time interval option by checking and setting the field Interval.
- (6) You can push  button to configure RINEX options. Set the options for RINEX headers, navigation systems, observation types or frequencies with "Options" dialog .

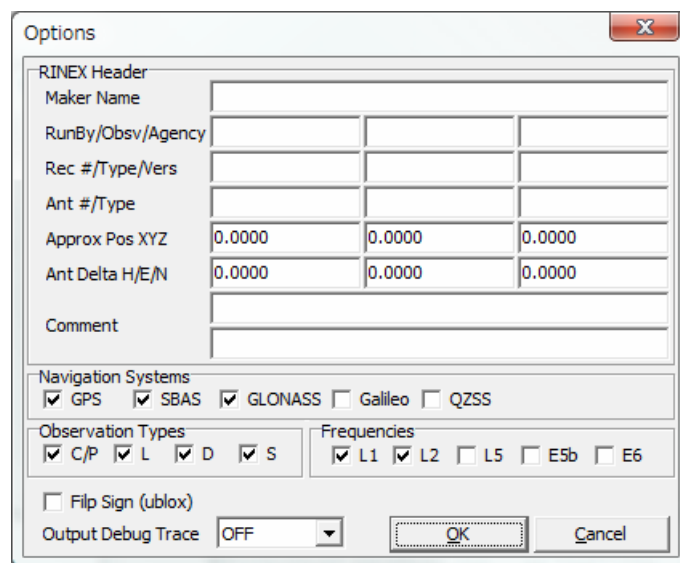

- (7) Push **Convert** button to start converting the receiver raw data to RINEX and SBAS log files. If you want to stop the conversion on the way, push **Abort** button. The status is displayed in the message area lower center in the main window. The message **O=nnn** means the number of converted observation data (epochs). The message **N=nnn**, **S=nnn** and **E=nnn** means the number of navigation messages, SBAS messages and errors, respectively.
- (12) After finishing the conversion, you can see the observation data plot by pushing **Plot...** button with RTKPLOT. Refer 3.7 Plot and View Solutions and Observation Data for details. You can also view the output file with Text Viewer by pushing  button.

### 3.7 View and Plot Solutions and Observation Data with RTKPLOT

RTKLIB contains the AP RTKPLOT to view and plot the positioning solutions by RTKLIB or RINEX observation data with graphical user interface.

- (1) Execute the binary AP file `rtklib_<ver>\bin\rtkplot.exe`. You can see the main window of RTKPLOT. By pushing `Plot...` button or some buttons of RTKPOST and RTKCONV, RTKPLOT is also executed.

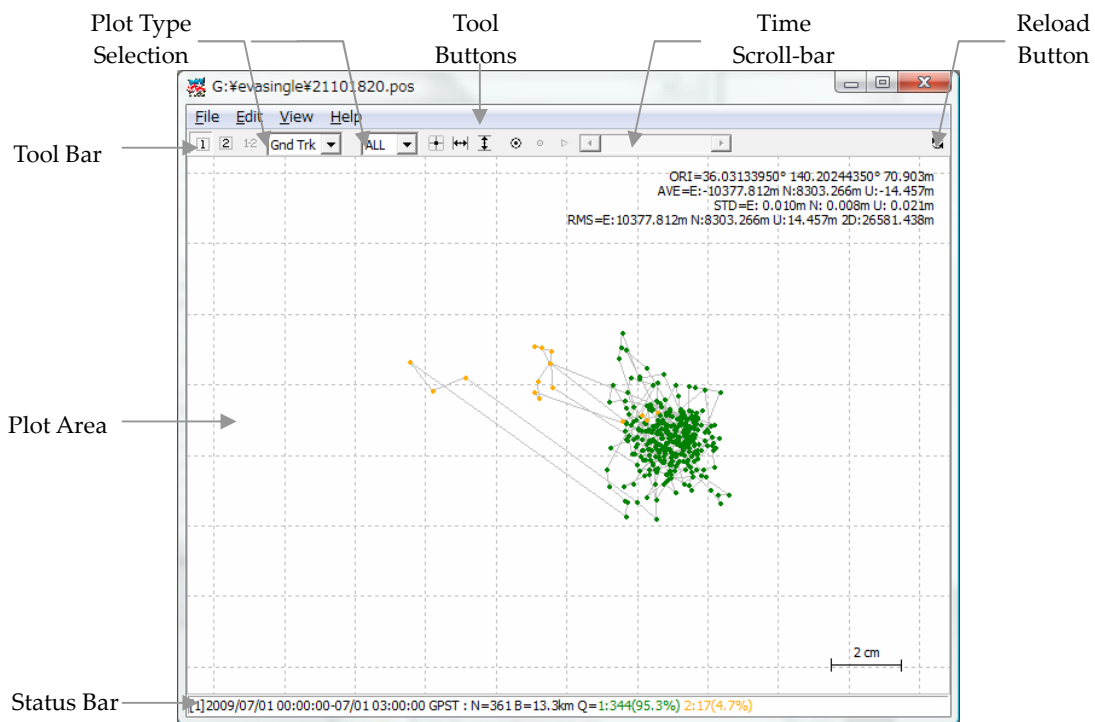



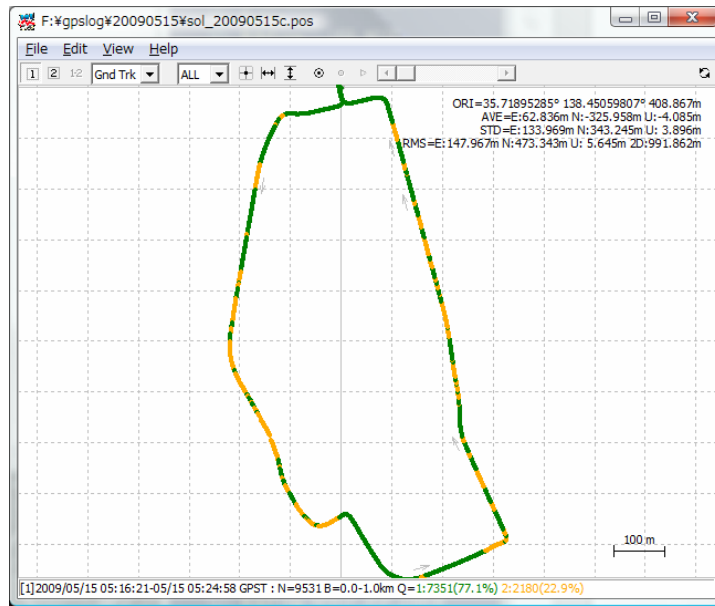



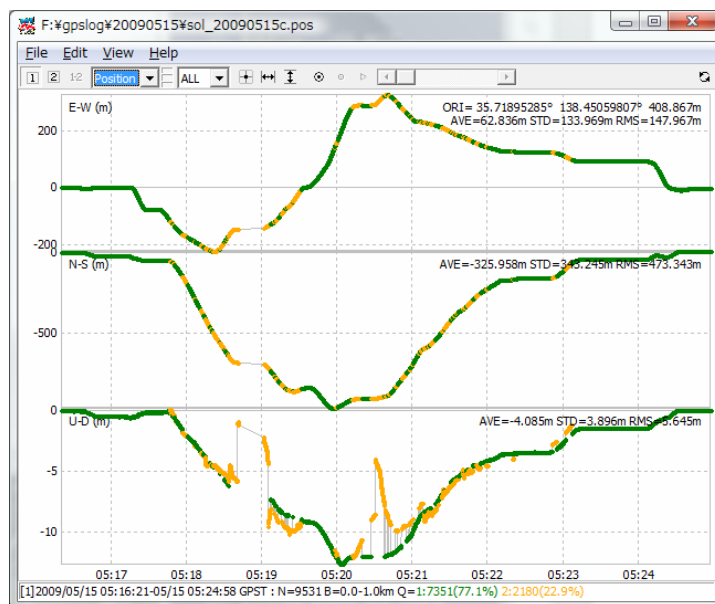



- (2) Execute the menu "File" - "Open Solution 1" and select the solution file with the file selection dialog. The input solution file can be RTKLIB solution format or NMEA-0183. If the file format is NMEA, the file has to contain at least GPRMC and GPSSGA sentences. If the solution file is valid, the receiver ground track is plot in the window on the map. The color of the marks, lines and grid in the plot can be changed with menu "Edit" - "Options". The status bar at the bottom of the main window also shows the time range, the number of solution epochs (**N=nnnn**), the baseline length (**B=0.0-x.xkm**), the number and percentage of each quality solutions (**Q=1:nnn (pp%)**, **2:nnn (pp%)**, ...). The quality flag Q and the marker color means: **1: Fixed**, **2: Float**, **4: DGPS**, **5: Single** (the colors are changeable with the plot options). To screen the marks by the quality flag Q, select the second pull down menu in the Tool Bar. By drag and drop of the solution file icon to the main window of RTKPLOT, you can also read and plot the solution file.



- (3) By dragging the mouse with the left button down on the plot, you can drag the map up, down, left and right . You also change the scale of the map by dragging the mouse up or down with the right button or by rotating the scroll wheel of the mouse.
- (4) By selecting the pull down menu right in Tool Bar, you can switch the plot to E/N/U components of receiver position (Position), E/N/U components of receiver velocity (Velocity) or E/N/U components of receiver acceleration (Accel). You can drag the X/Y-axis with the left-button dragging and change the scale with the right-button dragging at the X/Y-axis area.



- (5) By operating tool buttons in Tool Bar, you can center the current position with , adjust the scale of X-axis with , adjust the scale of Y-axis with , display the current position as a large mark with , fix the current position at the center with , start animation with  and stop animation with . You can also slide Time Scroll Bar to change the epoch of the current position. To reload the solution file, execute the menu "File" - "Reload" or push  button in Tool Bar.
- (6) To plot multiple solution file, execute the menu "File" - "Open Solutions-2" and select file with the file selection dialog. You can switch the plot on/off of the solution 1 and 2 with   buttons in Tool Bar. To Plot the difference of the solution 1 and the solution 2, push  button in Tool Bar.
- (7) To set the time range and time interval of the solutions, execute the menu "Edit" - "Time Span/Interval" and check and set the Time Start, Time End and Interval field in "Time Span/Interval" dialog.

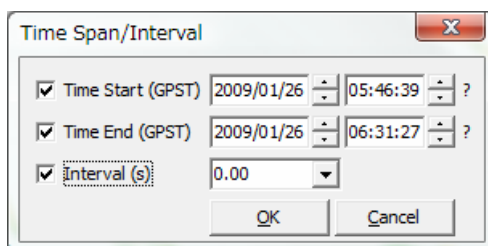

- (8) To plot the RINEX observation data, execute menu "File" -- "Open Obs Data" and select the RINEX observation and navigation message files. You can select multiple RINEX files. If you do not select the RINEX navigation message file, RTKPOST reads the observation data file paths with the extension replaced by **.nav** (**.obs**) or **.yyn** (**.yyo**) as the navigation data. If you want read the RINEX navigation message file separately, execute the menu "File" - "Open Nav Messages". If the input files can be read properly, you can see the satellite visibility or the observation data availability plot. You can use left-button or right-button drag to change the time span. You can also use some tool buttons in Tool Bar as well as  for the solution plot.

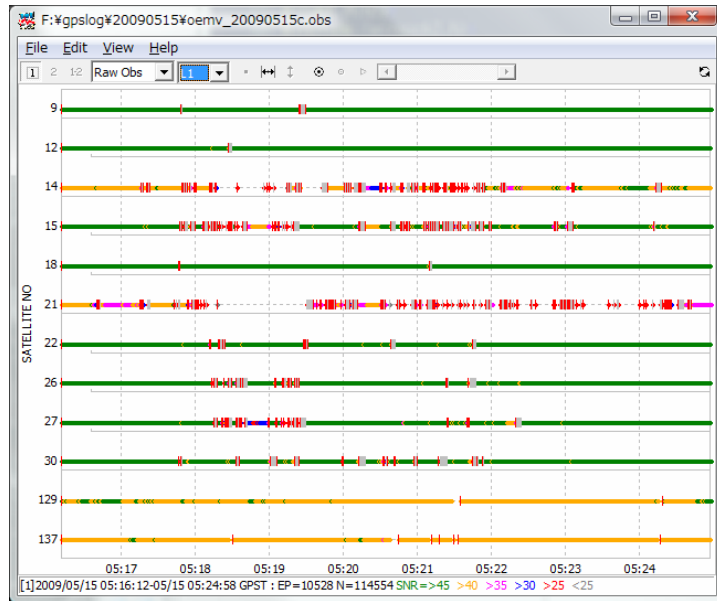

- (9) By selecting the pull down menu in Tool Bar, you can switch the plot to satellite visibility in skyplot (SkyPlot) or plot of number of visible satellites and DOP (Sats/DOP).

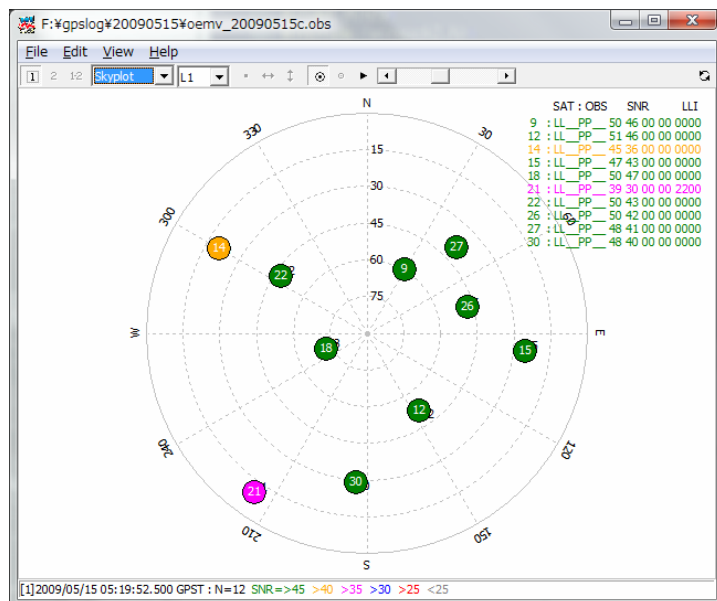

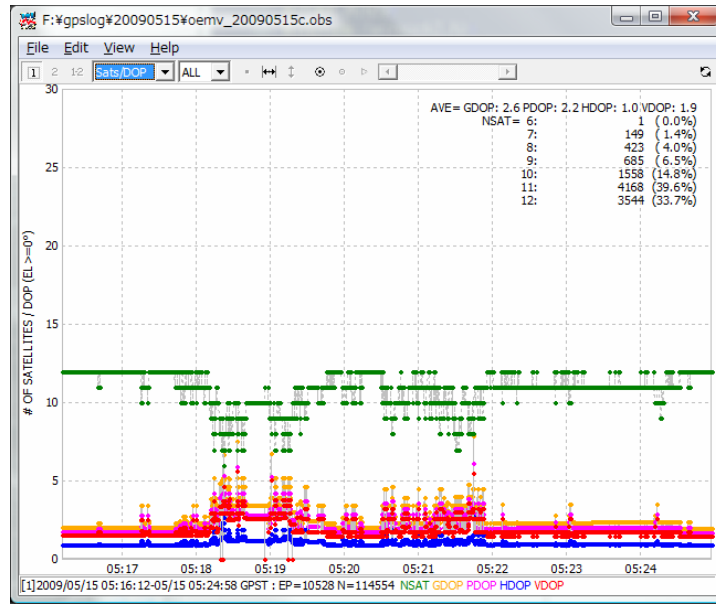

(10) To configure the plotting options, execute menu "Edit" - "Options..." and set the options with the following "Options" dialog.

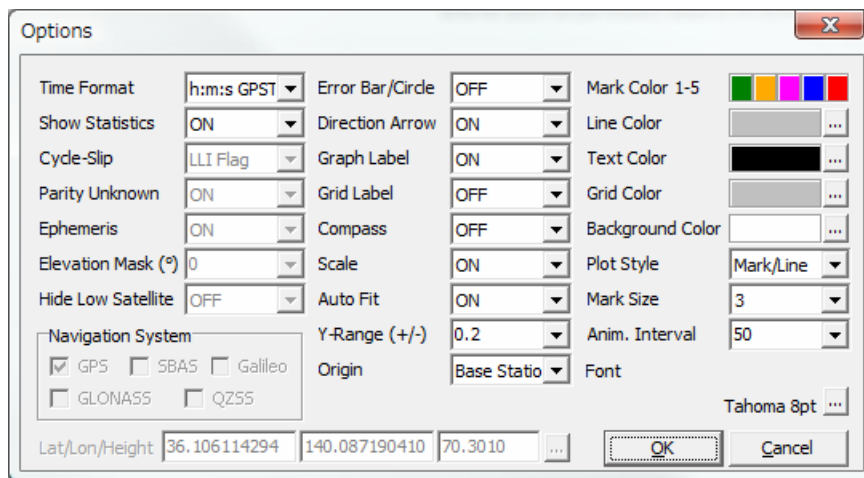

Item	Descriptions	Notes
Time Format	Select time format.	
Show Statistics	Set whether statistics are shown or not.	
Cycle-Slip	Set whether cycle-slip position is shown or not in observation data display. Cycle-slips are shown as red vertical lines in the observation data plot.	
Parity Unknown	Set whether parity unknown status is shown or not in observation data display. Parity unknown epochs are shown as gray vertical lines in the observation data plot.	







Item	Descriptions	Notes
Ephemeris	Set whether ephemeris status is shown or not in observation data display. Ephemerides are shown as the grey line under the observation data plot. Gray dots means the Toe. Red ephemeris plot means the satellite is unhealthy.	
Elevation Mask	Set the elevation mask angle (deg) for observation data display. The elevation mask is also used for DOP computation.	
Hide Low Satellite	Set whether low elevation satellites under the elevation mask is shown or not.	
Error Bar/Circle	Set whether error bar or error circle is shown or not in solution display.	
Direction Arrow	Set whether direction arrow is shown or not in solution ground track display.	
Graph Label	Set whether graph labels are shown or not in solution display.	
Grid Label	Set whether grid labels are shown or not in solution display.	
Compass	Set whether compass is shown or not in solution ground track display.	
Scale	Set whether scale is shown or not in solution ground track display.	
Auto Fit	Set whether scale is adjusted automatically or not.	
Y-Range (+/-)	Set the range of Y-axis in solution display.	
Origin	Select the origin position of solution display. If you select Lat/Lon/Height, you have to input latitude, longitude and ellipsoidal height in the text fields below for the origin.	
Mark Color	Set the mark colors in plots. Click color panel right and select color with color selection dialog.	
Line Color	Set the line color in plots.	
Text Color	Set the text color in plots.	
Grid Color	Set the grid color in plots.	
Background Color	Set the background color in plots.	
Plot Style	Select the plot style in plots.	
Mark Size	Set the mark size in plots.	
Anim. Interval	Set the animation interval for solution or observation data display.	
Font	Select the font in plots. Push ... button and select the font with font selection dialog.	

### 3.8 NTRIP Source Table Browser

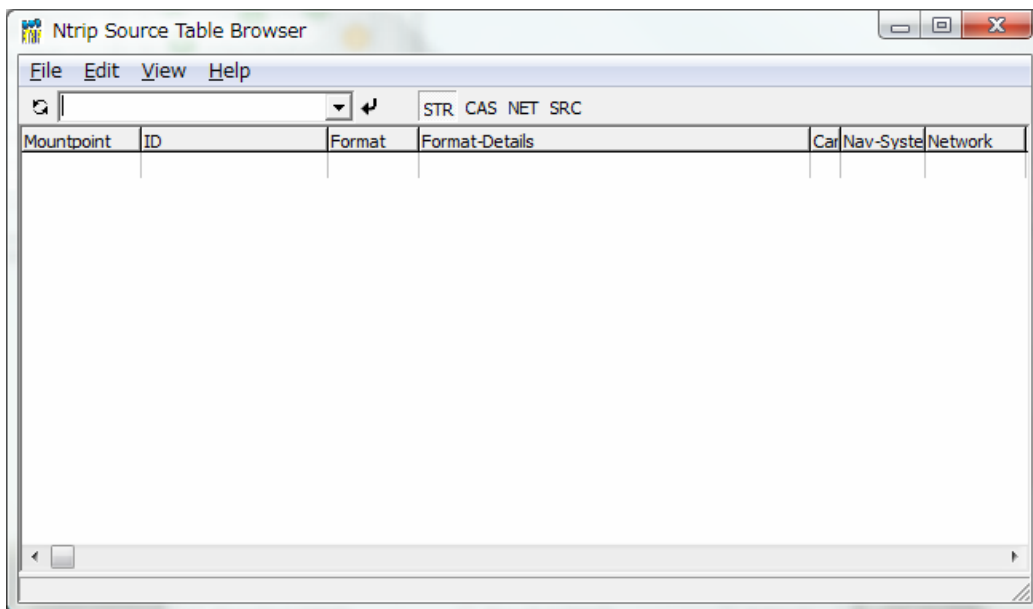
NTRIP (Networked Transport of RTCM via Internet Protocol) is a communication protocol to interchange GPS/GNSS related data such as receiver raw observation data, ephemerides and corrections for DGPS or RTK-GPS. NTRIP specifies the table format of so-called Source Table, which represents contents list of provided data by NTRIP servers. RTKLIB includes a simple browser for NTRIP Source Tables.

- (1) Execute the binary AP file `rtklib_<ver>\bin\srctblbrows.exe`. You can see the main window of NTRIP Source Table Browser.



- (2) Push  button upper left in the main window, leaving right pull down menu of NTRIP caster list blank. If the bottom status bar shows "connecting..." and then "update caster list", the NTRIP caster list is updated. If the pull down menu is blank, the browser acquires the NTRIP caster list from the default NTRIP info caster `rtcm-ntrip.org:2101` and update the list. To change the source of the list, fill the NTRIP caster address as the form of `<address>:<port>` in the pull down menu and push  button. If you omit port number, the browser uses the default port number 2101.
- (3) Select the caster in the pull down menu and push  button. If the status bar shows "source table received", the browser properly received a NTRIP Source Table from the selected NTRIP caster and shows it in the window. The status bar also indicate the error message if a problem arises.

Mountpoint	ID	Format	Format-Details	Cat	Net	System	Network	Count	Latitude	Longitude	Hm	Sol	Generator	Comd	Aut	Fed	Bit
ADIS0	Addis_Ababa	RTCM 3.0	1004(1),1006(10),1007(10),1019,1020	2	GPS	IGS	ETH	9.03	38.74	0	0	JPS LEGACY	none	B	N	130	
ADIS1	A-GPS-Addis_Ababa	RTCM 3.0	1019(5),1020(5)	2	GPS	IGS	ETH	9.03	38.74	0	0	JPS LEGACY	none	B	N	130	
ALBH0	Albert-Head	RTIGS	SOC(1)	2	GPS	IGS	CAN	48.39	236.51	0	0	AOA BENCHMARK ACT	none	B	N	130	
ALGO0	Algonquin-Park	RTIGS	SOC(1)	2	GPS	IGS	CAN	45.96	281.93	0	0	AOA BENCHMARK ACT	none	B	N	130	
ALIC0	Alice_Springs	RTCM 3.1	1004(1),1006(15),1008(15),1012(1)	2	GPS+GLO	IGS	AUS	-23.67	133.88	0	0	LEICA GRX1200GGPRO	none	B	N	160	
AUCX0	Auckland	RTCM 3.0	1004(1),1006(15),1008(15)	2	GPS	IGS	NZL	-36.60	174.83	0	0	TRIMBLE NETRS	none	B	N	150	
AZU10	Azusa	RTCM 3.0	1004(1),1006(15),1008(15)	2	GPS	IGS	USA	34.13	242.10	0	0	TRIMBLE NETRS	none	B	N	250	
BOGI0	Borowa_Gora	RTCM 2.1	3(10),18(1),19(1),22(10)	2	GPS+GLO	IGS	POL	52.48	21.04	0	0	JPS LEGACY	none	B	N	400	
BOR10	Borowiec	RTCM 2.3	1(1),3(10),18(1),19(1),22(10)	2	GPS	IGS	POL	52.28	17.07	0	0	TRIMBLE NETRS	none	B	N	240	
BRAZ0	Brasilia	RTCM 3.0	1004(1),1006(10),1007(10),1013(10)	2	GPS	IGS	BRA	-15.93	-47.87	0	0	TRIMBLE NETRS	none	B	N	500	
BRST0	Brest	RTCM 3.0	1004(1),1006(15),1008(15),1012(1)	2	GPS+GLO	IGS	FRA	48.38	-4.49	0	0	LEICA GRX1200GGPRO	none	B	N	200	
BRUS0	Brussels	RTIGS	SOC(1)	2	GPS	IGS	BEL	50.80	4.36	0	0	ASHTECH Z-XII3T	none	B	N	130	
BUCJ0	Bucharest	RTCM 3.0	1004(1),1006(10),1008(10),1012(1),1019(120),112	2	GPS+GLO	IGS	ROU	44.46	26.12	0	0	LEICA GRX1200GGPRO	none	B	N	280	
BZG60	Bolzano	RTCM 2.3	1(1),3(15),18(1),19(1),22(15),23(15),24(15)	2	GPS	IGS	ITA	46.47	11.56	0	0	LEICA GRX1200GGPRO	none	B	N	360	
CAGZ0	Cagliari	RTCM 2.1	1(3),3(60),16(60),18(1),19(1),31(3)	2	GPS+GLO	IGS	ITA	39.14	8.97	0	0	TPS E_GGD	none	B	N	390	
CEDU0	Ceduna	RTIGS	SOC(1)	2	GPS	IGS	AUS	-31.87	133.81	0	0	ASHTECH UZ-12	none	B	N	170	
CHUR0	Churchill	RTIGS	SOC(1)	2	GPS	IGS	CAN	58.76	265.91	0	0	AOA SNR-8100 ACT	none	B	N	1300	
COCO0	Cocos_Island	RTIGS	SOC(1)	2	GPS	IGS	AUS	-12.19	96.83	0	0	ASHTECH UZ-12	none	B	N	2100	
CONZ0	Concepcion-TIGO	RAW	Compact(1)	2	GPS+GLO	IGS	CHL	-36.84	286.98	0	0	TPS E_GGD	none	B	N	3600	
CONZ1	Concepcion	RTCM 3.0	1004(1),1006(10),1007(10),1012(1),1019,1020	2	GPS+GLO	IGS	CHL	-36.84	286.98	0	0	TPS E_GGD	none	B	N	2400	
CONZ2	A-GPS-Concepcion	RTCM 3.0	1019(5),1020(5)	2	GPS+GLO	IGS	CHL	-36.84	286.98	0	0	TPS E_GGD	none	B	N	4400	
DAEJ0	Daejeon	RTCM 2.3	1(1),18(1),19(1),22(10),23(10),24(10),59(10)	2	GPS	IGS	KOR	36.40	127.37	0	0	TRIMBLE NETRS	none	B	N	5700	
DHLG3	Durmid_Hill	RTCM 2.3	18(0.5),19(0.5)	2	GPS	IGS	USA	33.39	244.21	0	0	ASHTECH Z-XII3	none	B	N	360	
DLEF0	Delft	RTIGS	SOC(1)	2	GPS	IGS	NLD	51.99	4.38	0	0	JPS LEGACY	none	B	N	1300	
DUND0	Dunedin	RTCM 3.0	1004(1),1006(15),1008(15)	2	GPS	IGS	NZL	-45.88	170.60	0	0	TRIMBLE NETRS	none	B	N	1500	
FFMJ2	A-GPS-Frankfurt	RTCM 3.0	1019(5),1020(5)	2	GPS+GLO	IGS	DEU	50.09	8.66	0	0	JPS LEGACY	none	B	N	4400	
FFM33	Frankfurt	RTCM 3.0	1004(1),1006(10),1007(10),1012(1),1019,1020	2	GPS+GLO	IGS	DEU	50.09	8.66	0	0	JPS LEGACY	none	B	N	2400	
FUNCO	Funchal	RTCM 3.0	1004(1),1006(60),1008(60),1012(1)	2	GPS+GLO	IGS	PRT	32.65	343.09	0	0	LEICA GRX1200GGPRO	none	B	N	1600	
GANP0	Ganovce	RTCM 3.0	1004(1),1006(10),1008(10),1012(1),1013(10),1013	2	GPS+GLO	IGS	SVK	49.03	20.32	0	0	TRIMBLE NETRS	none	B	N	1700	
GOPE0	Praha-Ondrejov	RTCM 2.2	1(1),3(60),16(60),18(1),19(1),22(60),31(1),36(1)	2	GPS+GLO	IGS	CZE	49.91	14.79	0	0	ASHTECH Z18	none	B	N	5600	
GRAZ3	Graz	RTCM 3.0	1004(1),1006(5),1007(5)	2	GPS	IGS	AUT	47.07	15.49	0	0	TRIMBLE NETRS	none	B	N	3300	
HERT0	Halsham	RTCM 3.0	1004(1),1006(15),1008(15),1012(1),1019(60),1012	2	GPS+GLO	IGS	GBR	50.87	0.33	0	0	LEICA GRX1200GGPRO	none	B	N	2200	
HLFX0	Halifax	RTIGS	SOC(1)	2	GPS	IGS	CAN	44.68	296.39	0	0	AOA BENCHMARK ACT	none	B	N	1300	
HNFT0	Cambridge	RTCM 3.0	1004(1),1006(60),1008(60),1012(1)	2	GPS+GLO	IGS	USA	38.35	283.92	0	0	LEICA GRX1200GGPRO	none	B	N	2400	
HOFN0	Hoeft	RTCM 3.0	1004(1),1006(10),1007(10),1012(1),1019,1020	2	GPS+GLO	IGS	ISL	64.27	344.81	0	0	TPS E_GGD	none	B	N	2400	
HUEG0	Huegeheim	RTCM 3.0	1004(1),1006(10),1007(10),1012(1),1019,1020	2	GPS+GLO	IGS	DEU	47.82	7.62	0	0	JPS LEGACY	none	B	N	3600	
IENGO	Torino	RTIGS	SOC(1)	2	GPS	IGS	ITA	45.02	7.64	0	0	ASHTECH Z-XII3T	none	B	N	1300	
ISTA0	Istanbul	RTCM 3.0	1004(1),1006(10),1007(10),1019	2	GPS	IGS	TUR	41.10	29.02	0	0	ASHTECH Z-XII3	none	B	N	1700	
JOZ20	Izefoslaw-Warsaw	RTCM 3.0	1004(1),1006(60),1008(60),1012(1)	2	GPS+GLO	IGS	POL	52.02	21.03	0	0	LEICA GRX1200GGPRO	none	B	N	3300	
KARR0	Karratha	RTIGS	SOC(1)	2	GPS	IGS	AUS	-20.98	117.10	0	0	ASHTECH UZ-12	none	B	N	1900	
KIR00	Kiruna	RTCM 3.0	1004(1),1006(10),1007(10),1012(1)	2	GPS+GLO	IGS	SWE	67.88	21.06	0	0	JPS EGGOT	none	B	N	6000	
KUOC0	Koumac	RTCM 3.0	1004(1),1006(5),1007(5),1019(1)	2	GPS	IGS	NCL	-20.55	164.28	0	0	TRIMBLE NETRS	none	B	N	2400	
LEI10	Leipzig	RTCM 3.0	1004(1),1006(10),1007(10),1012(1),1019,1020	2	GPS+GLO	IGS	DEU	51.33	12.37	0	0	JPS LEGACY	none	B	N	2400	

(4) By pushing field title, you can sort the list. You also can push **STR**, **CAS**, **NET**, **SRC** to switch the contents of the Source Table to Stream List, Caster List, Network List and Original Source Table.

```

SOURCE TABLE 200 OK
Server: NTRIP Caster 1.5.8/1.0
Content-Type: text/plain
Content-Length: 17462

CAS:www.igs-ip.net:2101:IGS-IP;BKG;0;DEU;50.12;8.69;http://www.igs-ip.net/home
CAS:rtcm-ntrip.org:2101:NtripInfoCaster;BKG;0;DEU;50.12;8.69;http://www.rtcm-ntrip.org/home
NET:IGS;BKG;B;N;http://igsch.jpl.nasa.gov/http://igsch.jpl.nasa.gov:80/igsch/station/general/skel;http://igs.bkg.bund.de/index_ntrip_reg.htm;n
NET:Misc;BKG;B;N;http://igs.bkg.bund.de/root ftp/NTRIP/streams/streamlist_igs-ip.htm;http://igs.bkg.bund.de:80/root ftp/NTRIP/station/rnxskl;ht
NET:IGLO;BKG;B;N;http://igs.bkg.bund.de/root ftp/NTRIP/streams/streamlist_igs-ip.htm;http://igs.bkg.bund.de:80/root ftp/IGLOS/station/rnxskl;ht
NET:Test;BKG;B;N;http://igs.bkg.bund.de/root ftp/NTRIP/streams/streamlist_igs-ip.htm;http://igs.bkg.bund.de:80/root ftp/NTRIP/station/rnxskl;CL
NET:GLOVE;BKG;B;N;http://igs.bkg.bund.de/root ftp/NTRIP/streams/streamlist_igs-ip.htm;http://igs.bkg.bund.de:80/root ftp/NTRIP/station/rnxskl;C
STR:ADIS0:Addis_Ababa;RTCM 3.0;1004(1),1006(15),1008(15),1012(1),1019,1020;2:GPS+GLO;IGS;ETH;9.03;38.74;0;0;JPS LEGACY;none;B;N;1300;none
STR:ALBH0:Albert-Head;RTIGS;SOC(1);2:GPS;IGS;CAN;48.39;236.51;0;0;AOA BENCHMARK ACT;none;B;N;1300;none
STR:ALGO0:Algonquin-Park;RTIGS;SOC(1);2:GPS;IGS;CAN;45.96;281.93;0;0;AOA BENCHMARK ACT;none;B;N;1300;none
STR:ALIC0:Alice_Springs;RTCM 3.1;1004(1),1006(15),1008(15),1012(1),1019,1020;2:GPS+GLO;IGS;AUS;-23.67;133.88;0;0;LEICA GRX1200GGPRO;none;B;N;1600;GA
STR:RUCX0:Auckland;RTCM 3.0;1004(1),1006(15),1008(15);2:GPS;IGS;NZL;-36.60;174.83;0;0;TRIMBLE NETRS;none;B;N;1500;GeoNet
STR:AZU10:Azusa;RTCM 3.0;1004(1),1006(15),1008(15);2:GPS;IGS;USA;34.13;242.10;0;0;TRIMBLE NETRS;none;B;N;2500;none
STR:BOGI0:Borowa_Gora;RTCM 2.1;3(10),18(1),19(1),22(10);2:GPS+GLO;IGS;POL;52.48;21.04;0;0;JPS LEGACY;none;B;N;4000;IGK
STR:BOR10:Borowiec;RTCM 2.3;1(1),3(10),18(1),19(1),22(10);2:GPS;IGS;POL;52.28;17.07;0;0;TRIMBLE NETRS;none;B;N;2400;SRC PAS
STR:BRZ00:Bresliao;RTCM 3.0;1004(1),1006(10),1007(10),1013(10);2:GPS;IGS;BRA;-15.93;-47.87;0;0;TRIMBLE NETRS;none;B;N;5000;BRMC
STR:BRST0:Brest;RTCM 3.0;1004(1),1006(15),1008(15),1012(1);2:GPS+GLO;IGS;FRA;48.38;-4.49;0;0;LEICA GRX1200GGPRO;none;B;N;2000;RGP-IP
STR:BRUS0:Brussels;RTIGS;SOC(1);2:GPS;IGS;BEL;50.80;4.36;0;0;ASHTECH Z-XII3T;none;B;N;1300;ROB
STR:BUCC0:Bucharest;RTCM 3.0;1004(1),1006(10),1008(10),1012(1),1019(120),1020(30);2:GPS+GLO;IGS;ROU;44.46;26.12;0;0;LEICA GRX1200GGPRO;none;B;N
STR:BRZO0:Bozano;RTCM 2.3;1(1),3(15),18(1),19(1),22(15),23(15),24(15);2:GPS;IGS;ITA;46.47;11.56;0;0;LEICA GRX1200GGPRO;none;B;N;3600;Bozano D
STR:CAGZ0:Cagliari;RTCM 2.1;1(3),3(60),16(60),18(1),19(1),31(3);2:GPS+GLO;IGS;ITA;39.14;8.97;0;0;TPS E_GGD;none;B;N;3900;Univ Cagliari, DIST
STR:CEDU0:Ceduna;RTIGS;SOC(1);2:GPS;IGS;AUS;-31.87;133.81;0;0;ASHTECH UZ-12;none;B;N;1700;GA
STR:CHUR0:Churchill;RTIGS;SOC(1);2:GPS;IGS;CAN;58.76;265.91;0;0;AOA SNR-8100 ACT;none;B;N;1300;none
STR:COCO0:Cocos_Island;RTIGS;SOC(1);2:GPS;IGS;AUS;-12.19;96.83;0;0;ASHTECH UZ-12;none;B;N;2100;GA
STR:CONZ0:Concepcion-TIGO;RAW;Compact(1);2:GPS+GLO;IGS;CHL;-36.84;286.98;0;0;TPS E_GGD;none;B;N;3600;none
STR:CONZ1:Concepcion;RTCM 3.0;1004(1),1006(10),1007(10),1012(1),1019,1020;2:GPS+GLO;IGS;CHL;-36.84;286.98;0;0;TPS E_GGD;none;B;N;2400;NtripS05
STR:CONZ2:A-GPS-Concepcion;RTCM 3.0;1019(5),1020(5);2:GPS+GLO;IGS;CHL;-36.84;286.98;0;0;TPS E_GGD;none;B;N;4400;NtripS05
STR:DAEJ0:Daejeon;RTCM 2.3;1(1),18(1),19(1),22(10),23(10),24(10),59(10);2:GPS;IGS;KOR;36.40;127.37;0;0;TRIMBLE NETRS;none;B;N;5700;Korea Astron
STR:DHLG3:Durmid_Hill;RTCM 2.3;18(0.5),19(0.5);2:GPS;IGS;USA;33.39;244.21;0;0;ASHTECH Z-XII3;none;B;N;3600;SCIGN/ICRN
STR:DLEF0:Delft;RTIGS;SOC(1);2:GPS;IGS;NLD;51.99;4.38;0;0;JPS LEGACY;none;B;N;1300;none
STR:DUDD0:Dunedin;RTCM 3.0;1004(1),1006(15),1008(15);2:GPS;IGS;NZL;-45.88;170.60;0;0;TRIMBLE NETRS;none;B;N;1500;GeoNet
STR:FFM20:A-GPS-Frankfurt;RTCM 3.0;1019(5),1020(5);2:GPS+GLO;IGS;DEU;50.09;8.66;0;0;JPS LEGACY;none;B;N;4400;none
STR:FFM33:Frankfurt;RTCM 3.0;1004(1),1006(10),1007(10),1012(1),1019,1020;2:GPS+GLO;IGS;DEU;50.09;8.66;0;0;JPS LEGACY;none;B;N;2400;none
STR:FUNCO:Funchal;RTCM 3.0;1004(1),1006(60),1008(60),1012(1);2:GPS+GLO;IGS;PRT;32.65;343.09;0;0;LEICA GRX1200GGPRO;none;B;N;1600;Instituto Geog
STR:GANP0:Ganovce;RTCM 3.0;1004(1),1006(10),1008(10),1012(1),1013(10),1033(10);2:GPS+GLO;IGS;SVK;49.03;20.32;0;0;TRIMBLE NETRS;none;B;N;1700;ht
STR:GOPE0:Praha-Ondrejov;RTCM 2.2;1(1),3(60),16(60),18(1),19(1),22(60),31(1),36(1);2:GPS+GLO;IGS;CZE;49.91;14.79;0;0;ASHTECH Z18;none;B;N;5600;
STR:GRAZ3:Graz;RTCM 3.0;1004(1),1006(5),1007(5);2:GPS;IGS;AUT;47.07;15.49;0;0;TRIMBLE NETRS;none;B;N;3300;APOS
STR:HERT0:Halsham;RTIGS;SOC(1);2:GPS;IGS;CAN;44.68;296.39;0;0;AOA BENCHMARK ACT;none;B;N;1300;none
STR:HLFX0:Halifax;RTIGS;SOC(1);2:GPS;IGS;CAN;44.68;296.39;0;0;AOA BENCHMARK ACT;none;B;N;1300;http://reali
STR:HOFN0:Hoeft;RTCM 3.0;1004(1),1006(10),1007(10),1012(1),1019,1020;2:GPS+GLO;IGS;ISL;64.27;344.81;0;0;TPS E_GGD;none;B;N;2400;none
    
```

### 3.9 Use Console APs of RTKLIB

RTKLIB includes the following console APs. To execute the APs, These APs only use standard C functions. So you can rebuild the APs on the non-Windows environment like LINUX, UNIX, MAC OS X and so on. RTKLIB also contains standard make environment for gcc. Refer Appendix A RTKLIB Console AP Commands for detailed the command line options for these APs.

(1) RNX2RTKP

Post-Processing Analysis. The console AP version of RTKPOST.

(2) POS2KML

Google Earth KML converter for solution files.

(3) CONVBIN

RINEX Converter of receiver raw data. The console AP version of RTKCONV.

(4) SBSPOS

Positioning with SBAS DGPS corrections.

(5) SBSDUMP

Dump the SBAS correction messages.

(6) STR2STR

Stream Server. Console AP version of STRSVR.

(Not supported in the current version)

## 4 Develop and Link user AP with RTKLIB

RTKLIB provide the following general purpose C-functions callable from user application program (AP). User can use these function to develop user original positioning APs.

- (1) Matrix and vector functions
- (2) Time and string functions
- (3) Coordinates transformation and geoid model
- (4) Navigation processing
- (5) Positioning models (troposphere, ionosphere, antenna PCV)
- (6) SBAS DGPS correction
- (7) Single point positioning
- (8) Carrier-based and code-based relative positioning
- (9) OTF integer ambiguity resolution
- (10) Receiver raw binary data input
- (11) Positioning solution/NMEA input/output
- (12) RINEX observation data/navigation message input/output
- (13) Precise ephemeris input
- (14) Stream data communication library
- (15) NTRIP (Networked Transport of RTCM via Internet Protocol) library
- (16) RTK-GPS positioning server
- (17) RTCM 2.3 and 3.0/3.1 message handling

The following instructions shows the way to utilize the library of RTKLIB in user AP.

- (1) Add the following include directive to the source program of user AP.

```
#include "rtklib.h"
```

- (2) Set the following compiler option to add RTKLIB source directory path to compiler include paths.

```
-I rtklib_<ver>\src
```

- (3) Add the necessary RTKLIB library source files to source programs set for the AP build. Refer Appendix C Library APIs for detailed library functions and source programs in RTKLIB.

## Appendix A Console AP Commands

### A.1 RNX2RTKP

#### SYNOPSIS

```
rnx2rtkp [option ...] file file [...]
```

#### DESCRIPTION

Read RINEX OBS/NAV files, compute receiver (rover) positions and output position solutions. The first RINEX OBS file shall contain receiver (rover) observations. For the relative mode, the second RINEX OBS file shall contain reference (base) receiver observations. At least one RINEX NAV file shall be included in input files. Command options are as follows. ([:default])

#### OPTIONS

```
-h          print help
-o output  output file [stdout]
-ts ds ts  start day/time (ds=y/m/d ts=h:m:s) [obs start time]
-te de te  end day/time   (de=y/m/d te=h:m:s) [obs end time]
-ti tint  time interval (sec) [all]
-p mode   mode (0:single,1:dgps,2:kinematic,3:static,4:moving-base) [2]
-m mask   elevation mask angle (deg) [15]
-f freq   number of frequencies for relative mode (1:L1,2:L1+L2) [2]
-v thres  validation threshold for integer ambiguity (0.0:no AR) [3.0]
-b        backward solutions [off]
-c        forward/backward combined solutions [off]
-i        instantaneous integer ambiguity resolution [off]
-e        output x/y/z-ecef position [latitude/longitude/height]
-l        output e/n/u-baseline [latitude/longitude/height]
-n        output NMEA-0183 GGA sentence [latitude/longitude/height]
-g        output latitude/longitude in the form of ddd mm ss.ss' [ddd.ddd]
-z        output height in geodetic height [ellipsoidal]
-t        output time in the form of yyyy/mm/dd hh:mm:ss.ss [sssss.ss]
-u        output time in utc [gpst]
-d col    columns of time under decimal point [3]
```

-s sep field separator [' ']

-r x y z reference (base) receiver ecef pos (m) [average of single pos]

### EXAMPLES

Example 1. Kinematic Positioning, L1+L2, output Latitude/Longitude/Height to STDOUT.

```
> rnx2rtkp 07590920.05o 30400920.05o 30400920.05n
```

Example 2. Single Point Positioning, El Mask=15deg, output NMEA GGA to file out.pos

```
> rnx2rtkp -p 0 -m 15 -n -o out.pos 07590920.05o 30400920.05n
```

Example 3. Static Positioning, L1, time form yyyy/mm/dd hh:mm:ss, output X/Y/Z-ECEF positions

```
> rnx2rtkp -p 3 -f 1 -t -e 07590920.05o 30400920.05o 30400920.05n
```

Example 4. Kinematic Positioning, Instantaneous AR, validation threshold=2, comma separator

```
> rnx2rtkp -i -v 2 -s , 07590920.05o 30400920.05o 30400920.05n
```

## A.2 POS2KML

### SYNOPSIS

```
pos2kml [option ...] file [...]
```

### DESCRIPTION

Read position file(s) and convert it to Google Earth KML file. Each line in the input file shall contain fields of time, position fields (Latitude/Longitude/Height or X/Y/Z-ECEF), and Quality flag (option). The line started with '%', '#', ';' is treated as comment. Command options are as follows. ([]:default)

### OPTIONS

```
-h          print help
-o file     output file [infile + .kml]
-c color    track color
            (0:off,1:white,2:green,3:orange,4:red,5:yellow) [5]
-p color    point color
            (0:off,1:white,2:green,3:orange,4:red,5:by qflag) [5]
-a          output altitude information [off]
-ag         output geodetic altitude [off]
-tg         output time stamp of gpst [off]
-tu         output time stamp of utc [gpst]
-i tint     output time interval (s) (0:all) [0]
-q qflg     output q-flags (0:all) [0]
-f n e h    add north/east/height offset to position (m) [0 0 0]
```



## A.3 CONVBIN

### SYNOPSIS

```
convbin [-ts y/m/d h:m:s] [-te y/m/d h:m:s] [-ti tint] [-r rcv] [-f freq]
        [-od] [-os] [-d dir] [-o ofile] [-n nfile] [-s sfile] file
```

### DESCRIPTION

Convert receiver raw data log file to RINEX OBS/NAV and SBAS message file. SBAS message file complies to RTKLIB SBAS message format. Support the following message formats.

```
RTCM 2           : Type 1, 3, 9, 14, 16, 17, 18, 19, 22
RTCM 3           : Type 1002, 1004, 1005, 1006, 1019
NovAtel OEMV/4   : RANGECPMB, RANGEB, RAWEPHEMB, IONUTCB, RAWWASSFRAMEB
NovAtel OEM3     : RGEb, RGED, REPB, FRMB, IONB, UTCB
u-blox LEA-4T/AEK-4T : RXM-RAW, RXM-SFRB
NovAtel Superstar II : ID#20, ID#21, ID#22, ID#23, ID#67
Hemisphere Crescent : BIN80, BIN94, BIN95, BIN96
```

### OPTIONS

```
file          input receiver binary log file
-ts y/m/d h:m:s  start time [all]
-te y/m/d h:m:s  end time [all]
-ti tint        observation data interval (s) [all]
-r format       log format type
                rtc2= RTCM 2
                rtc3= RTCM 3
                nov  = NovAtel OEMV/4
                oem3 = NovAtel OEM3
                ubx  = ublox AEK-4T(LEA-4T)
                ss2 = NovAtel Superstar II
                cres = Hemisphere Crescent
-f freq         number of frequencies [2]
-od             include doppler frequency [off]
-os            include snr [off]
```

```
-d dir    output directory [same as input file]
-o ofile  output RINEX OBS file    [<file>.obs]
-n nfile  output RINEX NAV file    [<file>.nav]
-s sfile  output SBAS message file [<file>.sbs]
```

If receiver type is not specified, type is recognized by the input file extension as follows.

```
*.rtcm2  RTCM 2
*.rtcm3  RTCM 3
*.gps    NovAtel OEMV/4
*.ubx    u-blox AEK-4T (LEA-4T)
*.log    NovAtel Superstar II
*.bin    Hemisphere Crescent
```

## A.4 SBSPOS

### SYNOPSIS

```
sbspos [option ...] file [...]
```

### DESCRIPTION

Single point positioning with SBAS DGPS corrections. Files shall include receiver RINEX OBS file, NAV file and SBAS message log file (.sbs).

### OPTIONS

```
-o output output file [stdout]
-b          SBAS satellite prn number [129]
-m mask    elevation mask angle (deg) [10]
-c mask    snr mask (dbHz) [0]
-p          single point positioing without SBAS DGPS corrections [off]
-l          apply SBAS long term corrections [all]
-i          apply SBAS ionospheric corrections [all]
-f          apply SBAS fast corrections [all]
-r          apply SBAS ranging [all]
-s          apply doppler smoothing [off]
-t file    output trace to file [off]
```

## A.5 SBSDUMP

### SYNOPSIS

sbsdump [option ...] file

### DESCRIPTION

Dump SBAS messages. Specify SBAS log as file.

### OPTIONS

-h            print help  
-b            sbas satellite prn number [129]  
-s            corrected satellite prn number [all]  
-f            dump fast correction messages [off]  
-i            dump ionospheric correction messages [off]  
-l            dump long term correction messages [off]  
-n            dump geo navigation message [off]  
-g            dump ionospheric grid points [off]  
-t            dump integrity messages [off]

## Appendix B File Formats

### B.1 Positioning Solution File

#### DESCRIPTION

A positioning solution file is just a text file as output of RTKNAVI or RTKPOST. The file is separated to records or lines by CR/LF. Each records consists of fields. The following table shows the format of the positioning solution file.

No	Record/Field	Description	Notes
1	File header	<p>The lines starting with "%" are header lines. The header lines contains some additional information or processing options as follows.</p> <ul style="list-style-type: none"> <li>% <b>program</b> : program version</li> <li>% <b>inp file</b> : Input file path</li> <li>% <b>obs start</b>: Observation data start time in GPS time</li> <li>% <b>obs end</b>: Observation data end time in GPS time</li> <li>% <b>pos mode</b>: Positioning mode option</li> <li>% <b>freqs</b>: Frequencies option</li> <li>% <b>solution</b>: Solution type option</li> <li>% <b>elev mask</b>: Elevation mask angle option</li> <li>% <b>snr mask</b>: SNR mask option</li> <li>% <b>ionos est</b>: Ionospheric parameter estimation option</li> <li>% <b>tropos est</b>: Tropospheric parameters estimation option</li> <li>% <b>amb res</b>: Integer ambiguity resolution options</li> <li>% <b>val thres</b>: Integer ambiguity validation option</li> <li>% <b>ref pos</b>: position of the antenna of the base station</li> </ul>	
2	Field indicator	<p>Field indicator starting with "%" line follows after File header. To recognize the field formats, RTKLIB uses these lines. Do not delete them.</p>	
3	Solution body	<p>Solution body consists of the following fields. The field contents are varied according to the positioning options.</p>	
(1)	Time	<p>The epoch time of the solution indicating the true receiver signal reception time (not indicates the time by receiver clock). The format is varied to the options.</p> <p><b>yyyy/mm/dd HH:MM:SS.SSS</b> : Calendar time in GPST, UTC or JST, the time system is indicated in Field indicator</p> <p><b>WWW SSSSSS.SSS</b> : GPS week and TOW (time of week) in seconds.</p>	
(2)	Receiver Position	<p>The rover receive antenna or marker position estimated varied according to the positioning options.</p>	

No	Record/Field	Description	Notes
		<p><b>+ddd.dddddddd +ddd.dddddddd hhhh.hhhh :</b> Latitude, longitude in degrees and height in m. Minus value means south latitude or west longitude. The height indicates ellipsoidal or geodetic according to the positioning options.</p> <p><b>+ddd mm ss.sss +ddd mm ss.sss hhhh.hhhh :</b> Latitude, longitude in degree, minute and second and height in m.</p> <p><b>+xxxxxxxxx.xxxx +yyyyyyyyy.yyyy +zzzzzzzz.zzzz :</b> X/Y/Z components of ECEF frame in m.</p> <p><b>+eeeeeeee.eeee +nnnnnnnnn.nnnn +uuuuuuuuu.uuuu :</b> E/N/U components of baseline vector in m. The local coordinate is referenced to the rover position.</p>	
(3)	Quality flag (Q)	<p>The flag which indicates the solution quality.</p> <p><b>1</b> : Fixed, solution by carrier-based relative positioning and the integer ambiguity is properly resolved.</p> <p><b>2</b> : Float, solution by carrier-based relative positioning but the integer ambiguity is not resolved.</p> <p><b>3</b> : Reserved</p> <p><b>4</b> : DGPS, solution by code-based DGPS solutions or single point positioning with SBAS corrections</p> <p><b>5</b> : Single, solution by single point positioning</p>	
(4)	Number of valid satellites (ns)	The number of valid satellites for solution estimation.	
(5)	Standard deviations (sdn, sde, sdu, sdne, sdeu, sdun)	<p>The estimated standard deviations of the solution assuming a priori error model and error parameters by the positioning options.</p> <p>The sdn, sde or sdu means N (north), E (east) or U (up) component of the standard deviations in m. The absolute value of sdne, sdeu or sdun means square root of the absolute value of NE, EU or UN component of the estimated covariance matrix. The sign represents the sign of the covariance. With all of the values, user can reconstruct the full covariance matrix.</p>	
(6)	Age of differential (age)	The time difference between the observation data epochs of the rover receiver and the base station in second.	
(7)	Ratio factor (ratio)	The ratio factor of "ratio-test" for standard integer ambiguity validation strategy. The value means the ratio of the squared sum of the residuals with the second best integer vector to with the best integer vector.	

**EXAMPLE**

```

% program : RTKLIB ver.2.3.0b
% inp file : G:\rtklibtest\20090831\omre196a.09o
% inp file : G:\rtklibtest\20090831\tevc196a.09o
% inp file : G:\rtklibtest\20090831\omre196a.09n
% obs start : 2009/07/15 07:10:00.0 GPST (week1540 285000.0s)
% obs end : 2009/07/15 07:59:50.0 GPST (week1540 287990.0s)
% pos mode : kinematic
% freqs : L1+L2

```

```

% solution : forward
% elev mask : 15.0 deg
% snr mask : 0.0 dBHz
% ionos est : on
% tropo est : on
% amb res : continuous
% val thres : 3.0
% ref pos : 32.574831620 -117.126551777 -28.1471
%
% (lat/lon/height=WGS84/ellipsoidal,Q=1:fix,2:float,4:dgps,5:single,ns=# of satellites)
% GPST latitude(deg) longitude(deg) height(m) Q ns sdn(m) sde(m)
sdu(m) sdne(m) sdeu(m) sdun(m) age(s) ratio
2009/07/15 07:10:00.000 32.560273272 -116.953525346 118.6783 1 10 0.0186 0.0202
0.0899 -0.0072 0.0089 -0.0249 0.00 4.5
2009/07/15 07:10:10.000 32.560273266 -116.953525340 118.6877 1 10 0.0144 0.0154
0.0776 -0.0058 0.0082 -0.0199 0.00 5.3
2009/07/15 07:10:20.000 32.560273262 -116.953525365 118.6853 1 10 0.0124 0.0131
0.0720 -0.0051 0.0078 -0.0173 0.00 5.3
2009/07/15 07:10:30.000 32.560273251 -116.953525345 118.6825 1 10 0.0111 0.0117
0.0686 -0.0046 0.0075 -0.0157 0.00 5.6
2009/07/15 07:10:40.000 32.560273275 -116.953525412 118.6827 1 10 0.0103 0.0108
0.0662 -0.0043 0.0073 -0.0146 0.00 4.7
2009/07/15 07:10:50.000 32.560273277 -116.953525429 118.6812 1 10 0.0097 0.0102
0.0644 -0.0041 0.0071 -0.0138 0.00 4.1
2009/07/15 07:11:00.000 32.560273249 -116.953525449 118.6817 1 10 0.0092 0.0097
0.0630 -0.0039 0.0069 -0.0132 0.00 4.2
2009/07/15 07:11:10.000 32.560273271 -116.953525464 118.6729 1 10 0.0088 0.0093
0.0618 -0.0038 0.0067 -0.0127 0.00 5.2
2009/07/15 07:11:20.000 32.560273246 -116.953525468 118.6772 1 10 0.0085 0.0089
0.0607 -0.0037 0.0066 -0.0123 0.00 6.1
2009/07/15 07:11:30.000 32.560273219 -116.953525461 118.6733 1 10 0.0083 0.0087
0.0598 -0.0036 0.0065 -0.0119 0.00 7.9
2009/07/15 07:11:40.000 32.560273216 -116.953525478 118.6771 1 10 0.0081 0.0085
0.0590 -0.0035 0.0064 -0.0117 0.00 9.0
2009/07/15 07:11:50.000 32.560273206 -116.953525489 118.6726 1 10 0.0079 0.0083
0.0582 -0.0035 0.0062 -0.0114 0.00 8.6
2009/07/15 07:12:00.000 32.560273201 -116.953525497 118.6744 1 10 0.0078 0.0081
0.0575 -0.0034 0.0061 -0.0112 0.00 7.5
2009/07/15 07:12:10.000 32.560273212 -116.953525455 118.6731 1 10 0.0077 0.0080
0.0568 -0.0034 0.0060 -0.0110 0.00 7.9

```





## Appendix C Library APIs (Application Program Interfaces)

The following table shows the list of RTKLIB library functions. For detailed API (calling convention, description of the function, input and output parameters and types, return value and type) for a library function, refer the header comment of each function in the source program in `rtklib_<ver>\src`. The definition of data types regarding to the APIs, refer the header file `rtklib.h` in `rtklib_<ver>\src`.

RTKLIB API FUNCTION LIST

Function	Description	Source Program
Satellite number/system functions		
<code>satno()</code>	Satellite system and PRN/slot number to satellite number	<code>rtkcmn.c</code>
<code>satsys()</code>	Satellite number to satellite system	<code>rtkcmn.c</code>
<code>satid2no()</code>	Satellite ID to satellite number	<code>rtkcmn.c</code>
<code>satno2id()</code>	Satellite number to satellite ID	<code>rtkcmn.c</code>
Matrix and vector functions		
<code>mat()</code>	New matrix	<code>rtkcmn.c</code>
<code>imat()</code>	New integer matrix	<code>rtkcmn.c</code>
<code>zeros()</code>	New zero matrix	<code>rtkcmn.c</code>
<code>eye()</code>	New identity matrix	<code>rtkcmn.c</code>
<code>dot()</code>	Inner Product	<code>rtkcmn.c</code>
<code>norm()</code>	Euclid norm	<code>rtkcmn.c</code>
<code>matcpy()</code>	Copy matrix	<code>rtkcmn.c</code>
<code>matmul()</code>	Multiply matrix	<code>rtkcmn.c</code>
<code>matinv()</code>	Inverse of matrix	<code>rtkcmn.c</code>
<code>solve()</code>	Solve linear equation	<code>rtkcmn.c</code>
<code>lsq()</code>	Least square estimation	<code>rtkcmn.c</code>
<code>filter()</code>	Kalman filter state update	<code>rtkcmn.c</code>
<code>smoother()</code>	Kalman smoother	<code>rtkcmn.c</code>
<code>matprint()</code>	Print matrix	<code>rtkcmn.c</code>
<code>matfprint()</code>	Print matrix to file	<code>rtkcmn.c</code>
Time and string functions		
<code>str2num()</code>	String to number	<code>rtkcmn.c</code>
<code>str2time()</code>	String to time	<code>rtkcmn.c</code>
<code>time2str()</code>	Time to string	<code>rtkcmn.c</code>
<code>epoch2time()</code>	Calendar day/time to time	<code>rtkcmn.c</code>
<code>time2epoch()</code>	Time to calendar day/time	<code>rtkcmn.c</code>
<code>gpst2time()</code>	GPSTIME to time	<code>rtkcmn.c</code>
<code>time2gpst()</code>	Time to GPSTIME	<code>rtkcmn.c</code>
<code>timeadd()</code>	Add time	<code>rtkcmn.c</code>
<code>timediff()</code>	Time difference	<code>rtkcmn.c</code>
<code>gpst2utc()</code>	GPSTIME to UTC	<code>rtkcmn.c</code>
<code>utc2gpst()</code>	UTC to GPSTIME	<code>rtkcmn.c</code>
<code>timeget()</code>	Get current time in UTC	<code>rtkcmn.c</code>
<code>time2doy()</code>	Time to Day of Year	<code>rtkcmn.c</code>
<code>adjgpsweek()</code>	Adjust gps week number	<code>rtkcmn.c</code>
<code>tickget()</code>	Get current tick time	<code>rtkcmn.c</code>

Function	Description	Source Program
<code>sleepms ()</code>	Sleep for milli-seconds	<code>rtkcmn.c</code>
	Coordinates functions	
<code>ecef2pos ()</code>	ECEF to geodetic position	<code>rtkcmn.c</code>
<code>pos2ecef ()</code>	Geodetic to ECEF position	<code>rtkcmn.c</code>
<code>ecef2enu ()</code>	ECEF to local coordinates	<code>rtkcmn.c</code>
<code>enu2ecef ()</code>	Local to ECEF coordinates	<code>rtkcmn.c</code>
<code>covenu ()</code>	Covariance in local coordinates	<code>rtkcmn.c</code>
<code>covecef ()</code>	Covariance in ECEF coordinates	<code>rtkcmn.c</code>
<code>xyz2enu ()</code>	ECEF to ENU local coordinate transformation matrix	<code>rtkcmn.c</code>
	Input/output functions	
<code>readpcv ()</code>	Read antenna phase center parameters	<code>rtkcmn.c</code>
<code>readpos ()</code>	Read station positions	<code>rtkcmn.c</code>
<code>sortobs ()</code>	Sort observation data	<code>rtkcmn.c</code>
<code>unigeph ()</code>	Delete duplicated ephemeris	<code>rtkcmn.c</code>
<code>screent ()</code>	Screen data by time and interval	<code>rtkcmn.c</code>
	Debug trace functions	
<code>traceopen ()</code>	Open trace file	<code>rtkcmn.c</code>
<code>traceclose ()</code>	Close trace file	<code>rtkcmn.c</code>
<code>trace ()</code>	Output trace	<code>rtkcmn.c</code>
<code>tracet ()</code>	Output trace with time tag	<code>rtkcmn.c</code>
<code>tracemat ()</code>	Output trace as matrix printing	<code>rtkcmn.c</code>
<code>traceobs ()</code>	Output trace as observation data printing	<code>rtkcmn.c</code>
<code>traceonav ()</code>	Output trace as navigation messages printing	<code>rtkcmn.c</code>
<code>traceb ()</code>	Output trace as binary dump	<code>rtkcmn.c</code>
	Platform dependent functions	
<code>execcmd ()</code>	Execute command	<code>rtkcmn.c</code>
<code>expath ()</code>	Expand file path	<code>rtkcmn.c</code>
	Positioning models	
<code>eph2pos ()</code>	GPS ephemeris to satellite position/clock-bias	<code>rtkcmn.c</code>
<code>geph2pos ()</code>	GLONASS ephemeris to satellite position/clock-bias	<code>rtkcmn.c</code>
<code>satpos ()</code>	Satellite positions/clock-biases	<code>rtkcmn.c</code>
<code>satposv ()</code>	Satellite positions/velocities/clock-biases/clock-drifts	<code>rtkcmn.c</code>
<code>satposiode ()</code>	Satellite positions/clock-biases by IODE *	<code>rtkcmn.c</code>
<code>satazel ()</code>	Satellite azimuth/elevation angle	<code>rtkcmn.c</code>
<code>geodist ()</code>	Geometric distance	<code>rtkcmn.c</code>
<code>dops ()</code>	Compute DOPs	<code>rtkcmn.c</code>
<code>ionmodel ()</code>	Ionospheric model	<code>rtkcmn.c</code>
<code>ionmapf ()</code>	Ionospheric mapping function	<code>rtkcmn.c</code>
<code>tropmodel ()</code>	Tropospheric model	<code>rtkcmn.c</code>
<code>tropmapf ()</code>	Tropospheric mapping function (NMF)	<code>rtkcmn.c</code>
<code>antmodel ()</code>	Antenna model	<code>rtkcmn.c</code>
<code>csmooth ()</code>	Carrier smoothing	<code>rtkcmn.c</code>
	Single-point positioning	
<code>pntpos ()</code>	Single-point positioning	<code>rtkcmn.c</code>
<code>pntvel ()</code>	Velocity estimation by Single-point positioning	<code>rtkcmn.c</code>
	Geoid model	

Function	Description	Source Program
<b>geoidh()</b>	Geoid height	<b>geoid.c</b>
	Datum transformation	
<b>loaddatum()</b>	Load datum transformation parameter	<b>datum.c</b>
<b>tokyo2jgd()</b>	Tokyo datum to JGD2000 datum	<b>datum.c</b>
<b>jgd2tokyo()</b>	JGD2000 datum to Tokyo datum	<b>datum.c</b>
	RINEX functions	
<b>readrnx()</b>	Read RINEX files	<b>rinex.c</b>
<b>readrnxt()</b>	Read RINEX files in time range/interval	<b>rinex.c</b>
<b>outrnxobsh()</b>	Output RINEX OBS header	<b>rinex.c</b>
<b>outrnxobsb()</b>	Output RINEX OBS body	<b>rinex.c</b>
<b>outrnxnavh()</b>	Output RINEX NAV header	<b>rinex.c</b>
<b>outrnxnavb()</b>	Output RINEX NAV body	<b>rinex.c</b>
<b>uncompress()</b>	Uncompress file	<b>rinex.c</b>
<b>convrnx()</b>	RINEX converter	<b>convrnx.c</b>
	Precise ephemeris functions	
<b>readsp3()</b>	Read SP3 file	<b>preceph.c</b>
<b>readsap()</b>	Read satellite antenna phase center position	<b>preceph.c</b>
<b>eph2posp()</b>	Satellite precise ephemeris to satellite position/clock-bias	<b>preceph.c</b>
<b>sat2posp()</b>	Satellite positions/clock-biases with precise ephemeris	<b>preceph.c</b>
	Receiver raw data functions	
<b>getbitu()</b>	Extract unsigned bits	<b>rtkcmn.c</b>
<b>getbits()</b>	extract signed bits	<b>rtkcmn.c</b>
<b>crc32()</b>	CRC32 parity	<b>rtkcmn.c</b>
<b>crc24q()</b>	CRC24Q parity	<b>rtkcmn.c</b>
<b>decode_word()</b>	Decode navigation data word	<b>rcvraw.c</b>
<b>decode_frame()</b>	Decode navigation data frame	<b>rcvraw.c</b>
<b>init_raw()</b>	Initialize receiver raw data control	<b>rcvraw.c</b>
<b>free_raw()</b>	Free receiver raw data control	<b>rcvraw.c</b>
<b>input_raw()</b>	Input receiver raw data from stream	<b>rcvraw.c</b>
<b>input_rawf()</b>	Input receiver raw data from file	<b>rcvraw.c</b>
	Receiver dependent functions	
<b>input_oem4()</b>	Input OEM4/V raw data from stream	<b>rcv/novatel.c</b>
<b>input_oem3()</b>	Input OEM3 raw data from stream	<b>rcv/novatel.c</b>
<b>input_ubx()</b>	Input u-blox raw data from stream	<b>rcv/ublox.c</b>
<b>input_ss2()</b>	Input Superstar II raw data from stream	<b>rcv/ss2.c</b>
<b>input_cres()</b>	Input Crescent raw data from stream	<b>rcv/crescent.c</b>
<b>input_oem4f()</b>	Input OEM4/V raw data from file	<b>rcv/novatel.c</b>
<b>input_oem3f()</b>	Input OEM3 raw data from file	<b>rcv/novatel.c</b>
<b>input_ubxf()</b>	Input u-blox raw data from file	<b>rcv/ublox.c</b>
<b>input_ss2f()</b>	Input Superstar II raw data from file	<b>rcv/ss2.c</b>
<b>input_cresf()</b>	Input Crescent raw data from file	<b>rcv/crescent.c</b>
	RTCM functions	
<b>init_rtcn()</b>	Initialize RTCM control	<b>rtcm.c</b>
<b>free_rtcn()</b>	Free RTCM control	<b>rtcm.c</b>
<b>input_rtcn2()</b>	Input RTCM2 message from stream	<b>rtcm.c</b>
<b>input_rtcn3()</b>	Input RTCM3 message from stream	<b>rtcm.c</b>

Function	Description	Source Program
<code>input_rtc2f()</code>	Input RTCM2 message from file	<code>rtc2.c</code>
<code>input_rtc3f()</code>	Input RTCM3 message from file	<code>rtc3.c</code>
	Solution functions	
<code>readsol()</code>	Read solutions	<code>solution.c</code>
<code>readsolt()</code>	Read solutions in time range/interval	<code>solution.c</code>
<code>outsolheads()</code>	Output solution header to string	<code>solution.c</code>
<code>outsols()</code>	Output solution body to string	<code>solution.c</code>
<code>outsollexs()</code>	Output extended solution to string	<code>solution.c</code>
<code>outsolheadf()</code>	Output solution header to file	<code>solution.c</code>
<code>outsolf()</code>	Output solution body to file	<code>solution.c</code>
<code>outsollexf()</code>	Output extended solution to file	<code>solution.c</code>
<code>setsolopt()</code>	Set solution output options	<code>solution.c</code>
<code>setsolformat()</code>	Set solution output format	<code>solution.c</code>
<code>outnmea_rmc()</code>	Set solution output format	<code>solution.c</code>
<code>outnmea_gga()</code>	Set solution output format	<code>solution.c</code>
<code>outnmea_gsa()</code>	Set solution output format	<code>solution.c</code>
<code>outnmea_gsv()</code>	Set solution output format	<code>solution.c</code>
	Convert solutions to Google Earth KML file	
<code>convkml()</code>	Convert solutions to Google Earth KML file	<code>convkml.c</code>
	SBAS functions	
<code>sbsreadmsg()</code>	Read SBAS message file	<code>sbas.c</code>
<code>sbsreadsmgt()</code>	Read SBAS message file in time range	<code>sbas.c</code>
<code>sbsoutmsg()</code>	Output SBAS messages	<code>sbas.c</code>
<code>sbsupdatestat()</code>	Update SBAS status	<code>sbas.c</code>
<code>sbsdecodemsg()</code>	Decode SBAS message	<code>sbas.c</code>
<code>sbssatpos()</code>	SBAS satellite position	<code>sbas.c</code>
<code>sbspntpos()</code>	SBAS point positioning with corrections	<code>sbas.c</code>
	Integer least-square estimation	
<code>lambda()</code>	LAMBDA/MLAMBDA integer least-square estimation	<code>lambda.c</code>
	Real-time kinematic positioning	
<code>rtkinit()</code>	Initialize RTK control struct	<code>rtkpos.c</code>
<code>rtkfree()</code>	Free RTK control struct	<code>rtkpos.c</code>
<code>rtkpos()</code>	RTK positioning	<code>rtkpos.c</code>
	Post-processing positioning	
<code>postpos()</code>	Post-processing positioning	<code>postpos.c</code>
<code>postposopt()</code>	Set post-processing positioning options	<code>postpos.c</code>
<code>readopts()</code>	Read positioning options	<code>postpos.c</code>
<code>writeopts()</code>	Write positioning options	<code>postpos.c</code>
	Stream data input/output functions	
<code>strinitcom()</code>	Initialize stream communication environment	<code>stream.c</code>
<code>strinit()</code>	Initialize stream	<code>stream.c</code>
<code>strlock()</code>	Lock stream	<code>stream.c</code>
<code>strunlock()</code>	Unlock stream	<code>stream.c</code>
<code>stropen()</code>	Open stream	<code>stream.c</code>
<code>strclose()</code>	Close stream	<code>stream.c</code>

Function	Description	Source Program
<b>strread()</b>	Read stream	<b>stream.c</b>
<b>strwrite()</b>	Write stream	<b>stream.c</b>
<b>strsync()</b>	Time sync stream	<b>stream.c</b>
<b>strstat()</b>	Get stream status	<b>stream.c</b>
<b>strsum()</b>	Get stream statistics summary	<b>stream.c</b>
<b>strsetopt()</b>	Set stream options	<b>stream.c</b>
<b>strgettime()</b>	Get current time from stream	<b>stream.c</b>
	Stream server functions	
<b>strsvrinit()</b>	Initialize stream server	<b>stream.c</b>
<b>strsvrstart()</b>	Start stream server	<b>stream.c</b>
<b>strsvrstop()</b>	Stop stream server	<b>stream.c</b>
<b>strsvrstat()</b>	Get stream server status	<b>stream.c</b>
	RTK server functions	
<b>rtksvrinit()</b>	Initialize RTK server	<b>rtksvr.c</b>
<b>rtksvrstart()</b>	Start RTK server	<b>rtksvr.c</b>
<b>rtksvrstop()</b>	Stop RTK server	<b>rtksvr.c</b>
<b>rtksvrlock()</b>	Lock RTK server	<b>rtksvr.c</b>
<b>rtksvrunlock()</b>	Unlock RTK server	<b>rtksvr.c</b>
<b>rtksvrostat()</b>	Get RTK observation data status	<b>rtksvr.c</b>
<b>rtksvrsstat()</b>	Get RTK stream status	<b>rtksvr.c</b>